

# NETZSCH

Proven Excellence.



## Thermogravimetric Analysis TG 309 *Libra*®

Method, Technique, Applications

Analyzing & Testing



# TG 309 *Libra*®

## UNLOCKING THE POWER OF THERMOGRAVIMETRY

Thermogravimetry has the ability for differentiation between individual components based on their distinct thermal behavior. By analyzing weight-loss profiles, users can deduce the composition of complex samples, enabling deeper understanding of their structure and properties.

### Revealing the Mysteries of Complex Mixtures and Material Transformations

Thermogravimetry (TG) is renowned for its precision and sensitivity. By subjecting a sample to controlled temperature increments while continuously measuring its weight change, TGA can detect even the slightest alterations in a material's mass. This level of sensitivity allows for pinpointing the exact temperatures at which various transformations occur, such as decomposition, volatilization, or oxidation. As a result, TGA provides valuable insights into a material's composition, providing such information as stability and degradation data for polymers along with data for material characterization and formulation.

### Ensuring Product Quality and Safety

For industries like pharmaceuticals, chemicals, and food, ensuring product stability is very important. Thermogravimetry plays a vital role in evaluating the thermal stability of materials over time. By subjecting samples to extended thermal cycling, researchers can assess their long-term stability, obtain initial information about shelf-life, and identify potential degradation pathways. This information is critical for quality control and regulatory compliance.

### Unlimited Versatility: Tailored for Diverse Applications

One of the remarkable qualities of thermogravimetry is that it can be adapted to a wide range of applications. From the polymer industry to materials engineering, and from pharmaceutical research to environmental science, TGA is a versatile technique that transcends disciplinary boundaries. Its capability of providing fundamental insights into materials makes it indispensable for materials characterization, from quality control to industrial research and academic applications.

# Thermogravimetric Analysis

## TGA Information

- Mass changes
- Compositional analysis
- Identification
- Decomposition
- Oxidation
- Thermal stability
- Reduction behavior
- Corrosion studies
- Determination of
  - filler content
  - plasticizer content
  - residual solvents
  - moisture content
  - added carbon black
  - ash content
  - purity
- Influence of aging
- Curie temperatures
- Reaction kinetics
- State of hydration
- Residual solvents

Various international standards describe the general principles of thermogravimetry for polymers (ISO 11358) or other specific applications, such as compositional analysis for rubber (ASTM D6370) and evaporation loss in lubricating oils (ASTM D6375).

## Measuring Principle

Thermogravimetric analysis (TGA) is a precise analytical technique used to track changes in the mass of a sample over time and/or temperature under a defined and controlled environment with respect to heating rate, gas atmosphere, flow rate, crucible type, etc. It can accurately detect weight changes down to fractions of a microgram. This high sensitivity allows for the determination of even the smallest changes in the physical and chemical properties of a material.

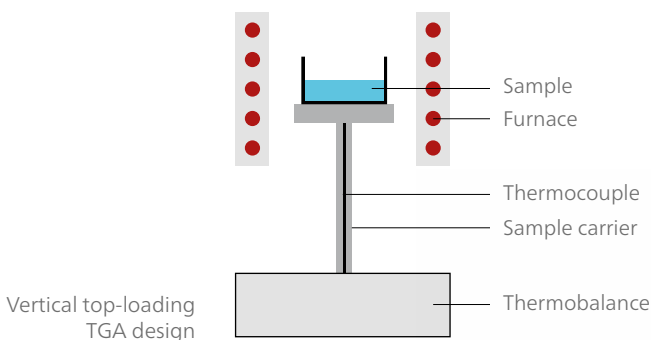

## One TGA Series – Three Instruments: The TG 309 *Libra*® *Classic*, *Select* and *Supreme*

NETZSCH offers a TGA solution for every need. We begin with the competitively priced TGA *Libra*® *Classic*, the perfect instrument for quality control. Next is the TG 309 *Libra*® *Select*, a work horse for testing in laboratories, including industrial development labs. And last but not least, the TG 309 *Libra*® *Supreme* is our all-in-one instrument for research labs in academia and industry.

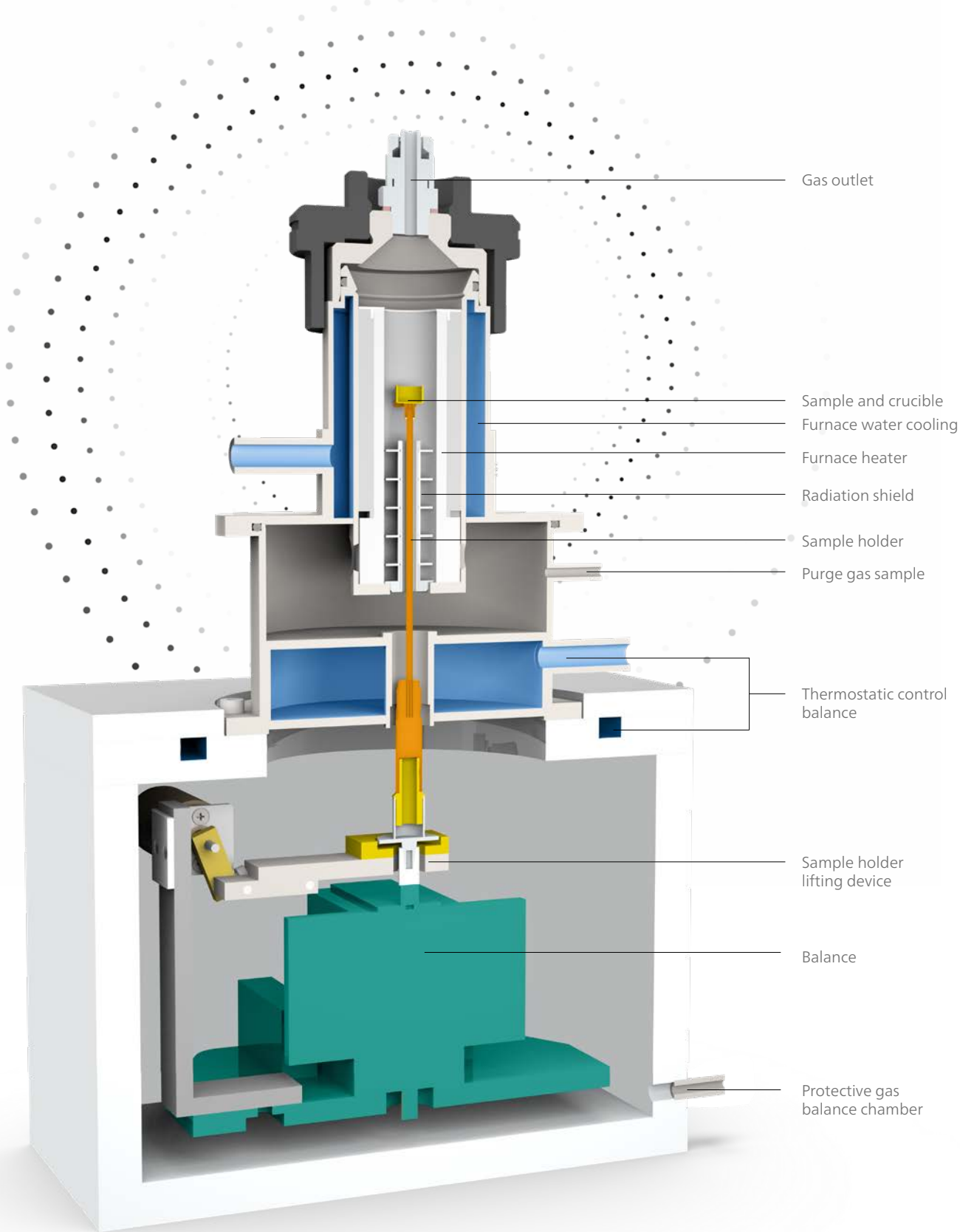

Explore the TG 309 *Libra*®



## Vertical Design Combined with Top-Loading Ultra-Microbalance for Easy and Safe Handling

The design of the vacuum-tight TG 309 *Libra*® ensures free and safe access to the sample, easy crucible exchange (no hang-down wires or horizontal balance beam), and a constant and stable position for the sample carrier in the furnace. This results in homogeneous temperature distribution and high sample-to-sample reproducibility.

## Precise Detection of Sample Temperature and *c-DTA*®

The sample temperature is detected by a thermocouple in direct contact with the sample crucible. This ensures accurate reading of the sample temperature, makes it nearly independent from the atmosphere, gas flow or heating rate and enables determination of the calculated DTA signal, *c-DTA*®.

This signal is ideal for easy temperature calibration and works by using melting standards. It also yields important information regarding endothermic and exothermic processes (e.g., melting or evaporation with mass loss).



## Magnetic Levitation for Interference-Free Determination of Sample Masses

The instrument can be raised using a magnetic levitation system (optional) that lifts and separates the instrument from the work bench. External influences from, for example, vibration or touching the instrument are eliminated; this reduces the number of measurements required to obtain reliable results.

## Four Mass Flow Controllers – Switching and Mixing Gases Made Easy

The addition of a fourth mass flow controller allows for the simultaneous connection of different gases, such as nitrogen, oxygen and carbon dioxide, plus an inert gas. This feature streamlines gas switching and mixing, eliminating the need for changing and cleaning gas connections and thus resulting in significant time savings.

## Micro-Furnace – A Dynamic System for Efficient Laboratory Work

The low-volume furnace supports fast heating rates over the entire temperature range and fast ballistic cooling by chilling from 1100°C down to room temperature. The low purge gas flows ensure less dilution of the evolved gases (to be considered if coupling to evolved gas analysis is planned). The short gas path, low volume of the furnace and low dead volume above the sample help prevent condensation of the evolved gases in the furnace.

## Safe and Easy Sample Handling

When the crucible is placed on the sample carrier, the microbalance is not affected because the carrier is lifted by an automatic hoisting device. Sample placement is therefore simple and user-friendly.



TG 309 *Libra*® Select/Supreme

# Vacuum-Tight by Design for Reproducible Measurement Conditions

Tests under vacuum for improved separation of decomposition steps

## AutoVac – Reproducible Results

The *AutoVac*\* feature allows for software-controlled automatic evacuation and gas filling, thus providing uniform measurement conditions. When mixtures or blends are measured at reduced pressure, boiling point depression can be realized for volatiles (e.g., solvents, plasticizers). This leads to better separation from the decomposition of the component. After release of the volatile, it is possible to backfill with an inert gas followed by, for example, an oxidizing atmosphere to continue the measurement for the complete decomposition.

\*optional

## Selection of Crucible Types<sup>1</sup>



Various crucible types made from different materials and in different volumes are available to fit your application needs. Here, only a small selection of crucibles is shown. Sample-crucible compatibility should always be taken into consideration (e.g., metallic crucibles may not be used for metal samples).

<sup>1</sup> For ASC: crucible diameter max. 8 mm

Application	Material	Diameter/Height	Volume
Standard TGA tests	Al <sub>2</sub> O <sub>3</sub>	6.8 mm/4 mm	85 µl
Standard TGA tests, high sample mass or volume	Al <sub>2</sub> O <sub>3</sub>	8.0 mm/8 mm; 9.0 mm/7 mm	300 µl; 350 µl
Ideal for c-DTA®, high sample mass or volume	Pt/Rh	6.8 mm/2.7 mm; 6.8 mm/6 mm	85 µl; 190 µl
Ideal for c-DTA®, up to max. 600°C	Al (99.5%)	6.7 mm/2.7 mm	85 µl



# Automatically Recognized Sample Holders



## The Right Sample Carrier<sup>1</sup> for Any Application

Various sample carriers are available including corrosion-resistant sensors, high-sensitivity *c-DTA*<sup>®</sup> sensors for improved monitoring of endo- and exothermic effects, and special sensors for large sample masses. The sample carriers can be changed out in less than one minute and are automatically recognized by the instrument.

<sup>1</sup> For ASC: crucible diameter max. 8 mm

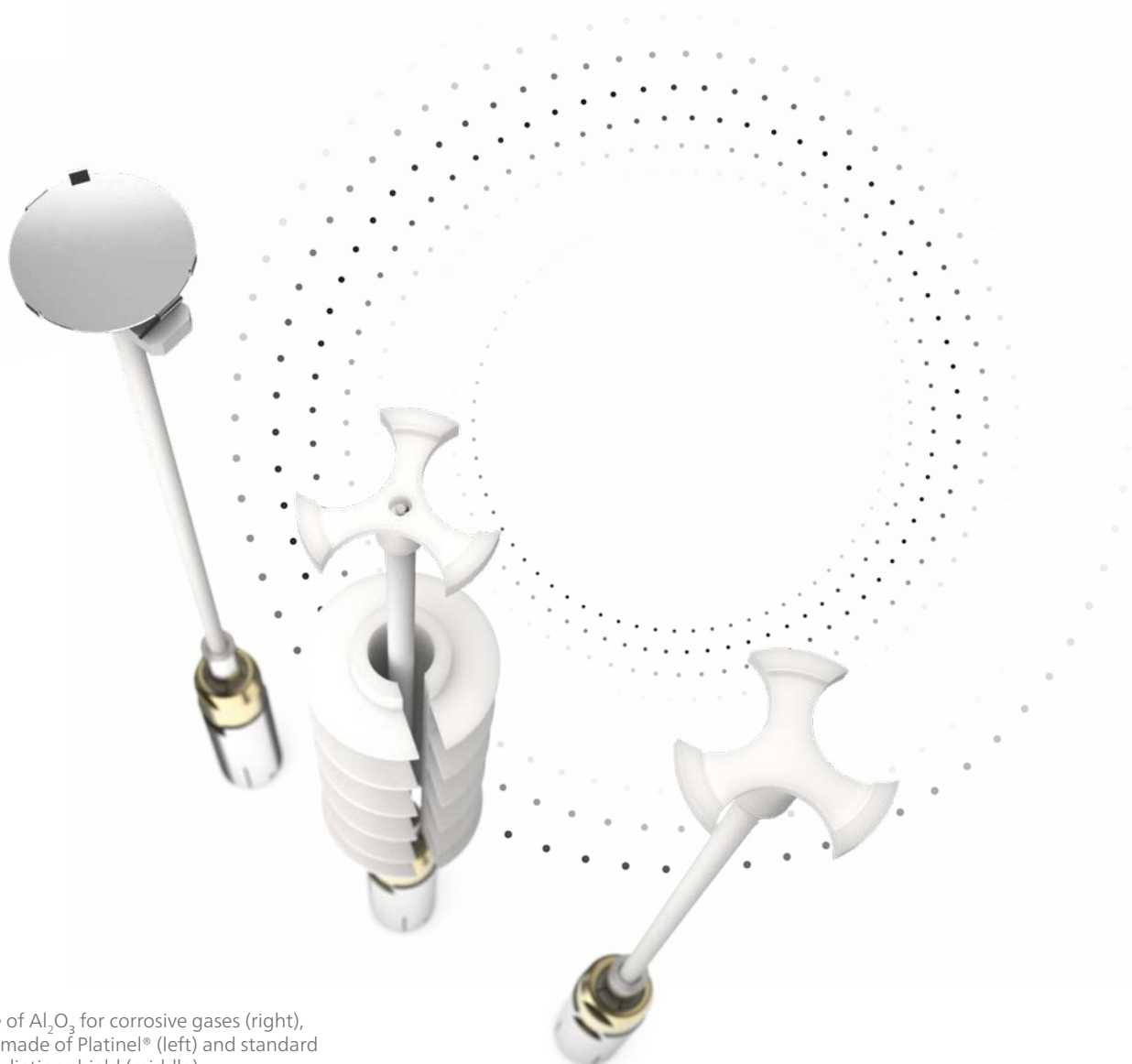

Sample carriers made of  $\text{Al}_2\text{O}_3$  for corrosive gases (right), sample carrier type P made of Platinel<sup>®</sup> (left) and standard sample carrier with radiation shield (middle).

# Automatic Sample Changer



## Improving Efficiency According to Your Needs

The Automatic Sample Changer (ASC) is easily programmed using *SmartMode* of the *Proteus*<sup>®</sup> software. A specific measuring program (method) can be assigned to each sample on the carousel. Different crucible types, different gas atmospheres and individual calibration curves can be handled within the same ASC run. Used samples are – if desired – automatically disposed of in the integrated waste bin. For 24/7 operation, previously measured samples can be continuously replaced by adding new crucibles to the carousel in combination with new measurement methods.

## ASC for TG 309 *Libra*<sup>®</sup> *Supreme* and *Select*

### High-End 204-Sample ASC and Removable Sample Trays

The TG 309 *Libra*<sup>®</sup> *Select* and *Supreme* ASC is designed to hold two interchangeable sample trays in microplate format, each holding 96 samples. This allows for clear assignment of the samples when they are prepared away from the instrument. An additional fixed strip is reserved for up to 12 calibration materials or empty crucibles of different dimensions and materials for calibration and correction purposes. Of course, correction measurements with empty crucibles can also be defined on the trays.

This large number of positions ensures total flexibility and more time for other important day-to-day tasks.

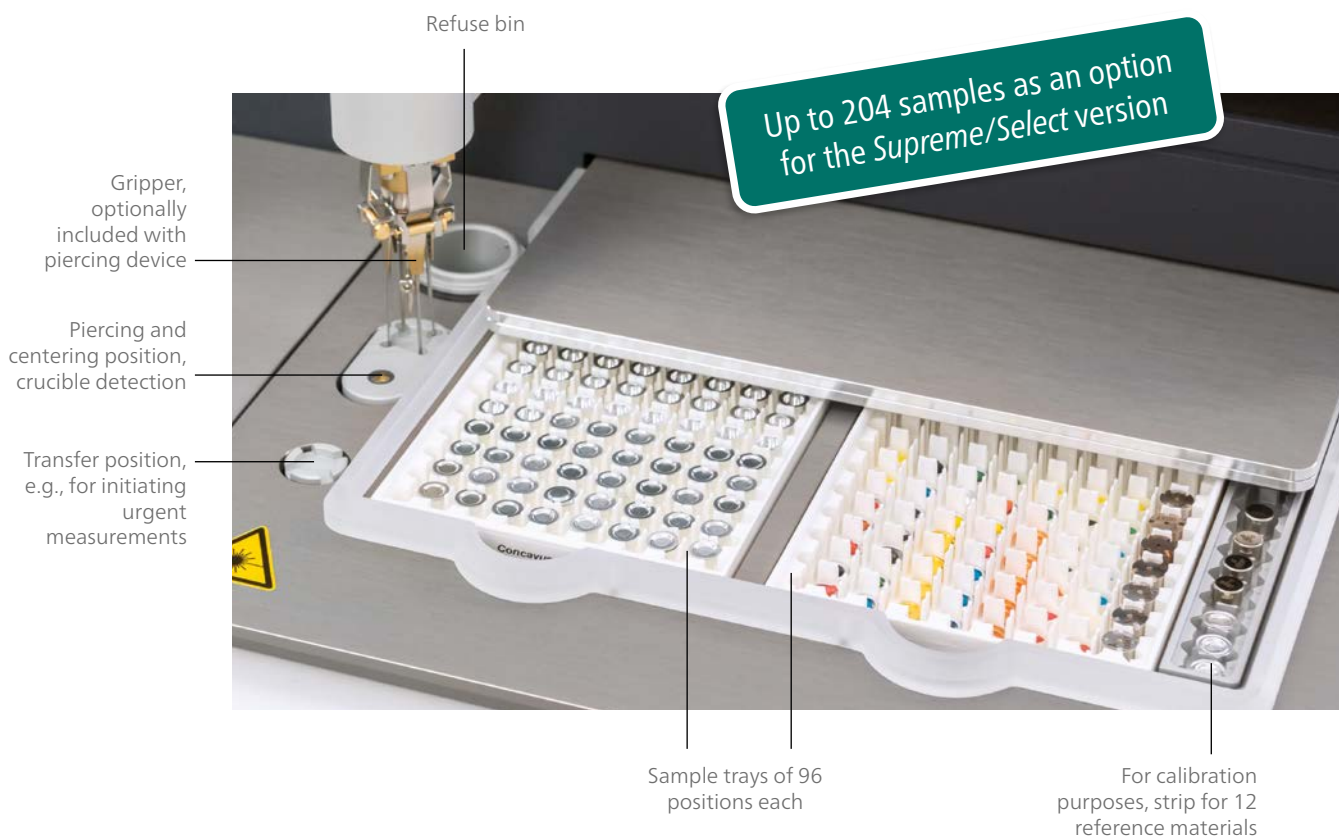



## Reducing Environmental Influences while Waiting

In order to prevent sample materials from being affected by the surrounding conditions – such as humidity – whilst waiting in the queue, the ASC is equipped with a tray cover. The interspace between the sample trays and the cover is purged with a defined gas to reduce contact with the surrounding environment.

In addition, a "RemoveCap" or lid-piercing feature is included to help protect unstable or volatile samples. Covering crucibles with unstable samples while they are waiting to be placed into the furnace minimizes the risk of them evaporating. An automatic piercing device attached to the gripper is also available as an option; this opens the lids of aluminum crucibles shortly before the measurement starts.

## ASC for TG 309 *Libra*® Classic

### Compact 20-Sample ASC on a Removable Sample Carousel

The cost-effective TG 309 *Libra*® Classic can be equipped with an optional automatic sample changer (ASC) for up to 20 samples and references. The gripper safely removes the crucible from the magazine and gently places it in position on the sensor. The samples are placed in a removable ASC insert which allows for preparation away from the instrument.



Removable Sample Carousel

Up to 20 samples as an option  
for the *Classic* version



TG 309 *Libra*® Classic



# PROTEUS® SOFTWARE

## BeFlat® – Measurement Results Quickly Obtained

### No Baseline Run Required – Get to Your Results Faster

In typical measurements, in order to ensure correct mass change values, a baseline run is carried out under identical test conditions for variables such as heating rate, gas type, gas flow rate, crucible type and geometry, etc., and subtracted from the sample measurement. The baseline takes instrument and buoyancy influences into consideration.

In contrast, the TG 309 *Libra*® generally no longer requires a separate baseline correction when using the integrated *BeFlat*® baseline run for typical temperature profiles. This greatly simplifies routine test work, especially for quality control in industry.

Simplification of work –  
state-of-the-art correction

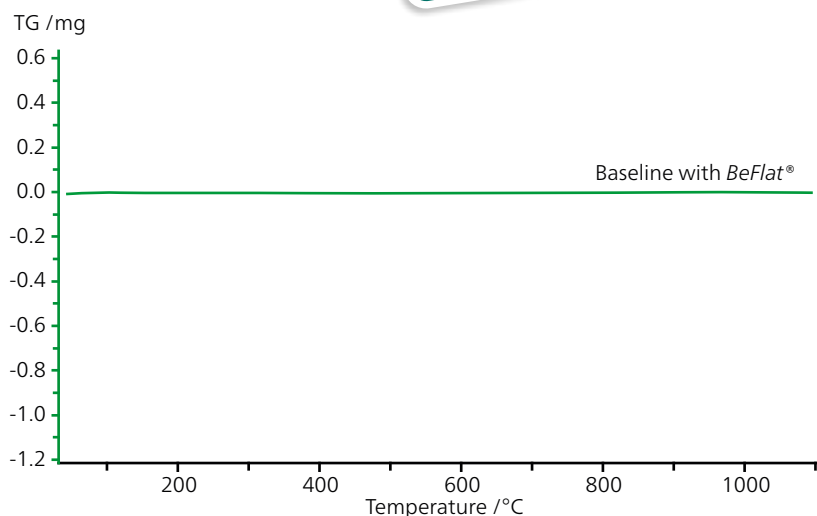

Stable baseline (green) thanks to automatic correction of external influences via TGA-*BeFlat*®

### *AutoCalibration* Allows for Full Concentration on the Measurement Tasks

Calibration procedures should be straightforward and efficient, ideally conducted in real-time. *AutoCalibration* offers automatic functions to generate calibration curves. It handles the current temperature calibrations under consideration of the selected measurement conditions and monitors their validity periods through a watchdog function.

### *SmartMode* for Routine Tasks – No More, No Less

*SmartMode* is an intuitive interface for fast measurement setup, designed specifically for the routine measurements often required in quality control. It allows you to quickly and easily prepare and start measurements for tasks using clearly defined measurement procedures. Wizards (quick start routines), user-defined measurement methods and predefined measurement methods are helpful assistants.

### *ExpertMode* – the Sky Is the Limit

For those who want to dive deeper into the software for advanced option setting or method definition, switching from *SmartMode* to *ExpertMode* is the answer. Here, the user has access to with its proven functionality of the *Proteus*® software, including dozens of features and all of the adjustment settings.

# Revealing Caloric Effects by Means of c-DTA<sup>®</sup>

## More Information through Caloric Effects – c-DTA<sup>®</sup>

The sample thermocouple is capable of detecting temperature changes within the sample. This makes it possible to also determine endothermic (e.g., melting) and exothermic effects during thermogravimetric experiments and to characterize sample properties in a more comprehensive way. In addition, this opens up a precise option for temperature calibration with DSC standard materials. The c-DTA<sup>®</sup> signal is calculated by comparing the measured sample temperature with the preset temperature-time program of the test run. The result is a DTA-like curve, as shown in red.

The two endothermal c-DTA<sup>®</sup> peaks (198°C and 535°C) in the TGA measurement on a kaolinite sample are

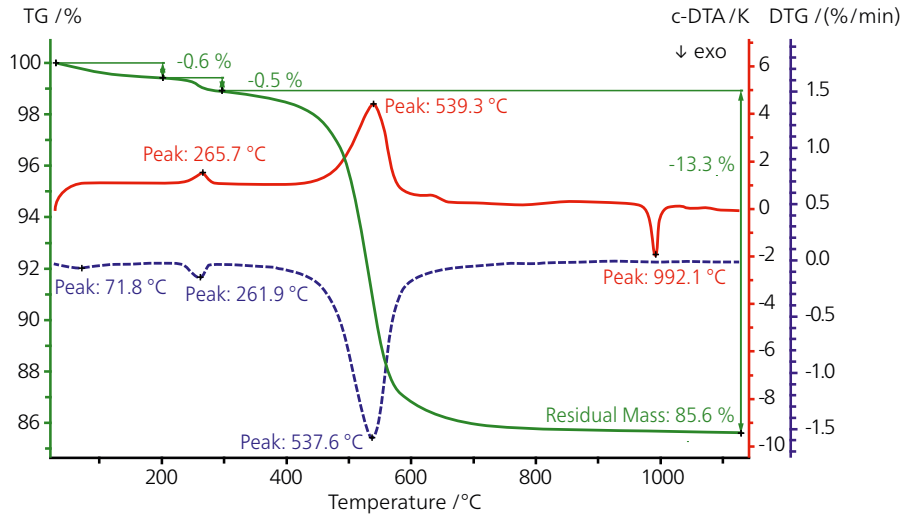

TGA measurement on a kaolinite sample (41.75 mg); joint presentation of the TGA curve (green), the DTG curve (blue, dashed line) and the c-DTA<sup>®</sup> curve (red), heated to 1100°C in a nitrogen atmosphere at 10 K/min.

directly related to the occurring mass-loss steps and are caused by dehydration and dehydroxylation: loss of adsorbed water from the surface (0.3%) and loss of water from inter layers (10.6%). The exothermal c-DTA<sup>®</sup> peak at 999°C represents the formation of mullite.

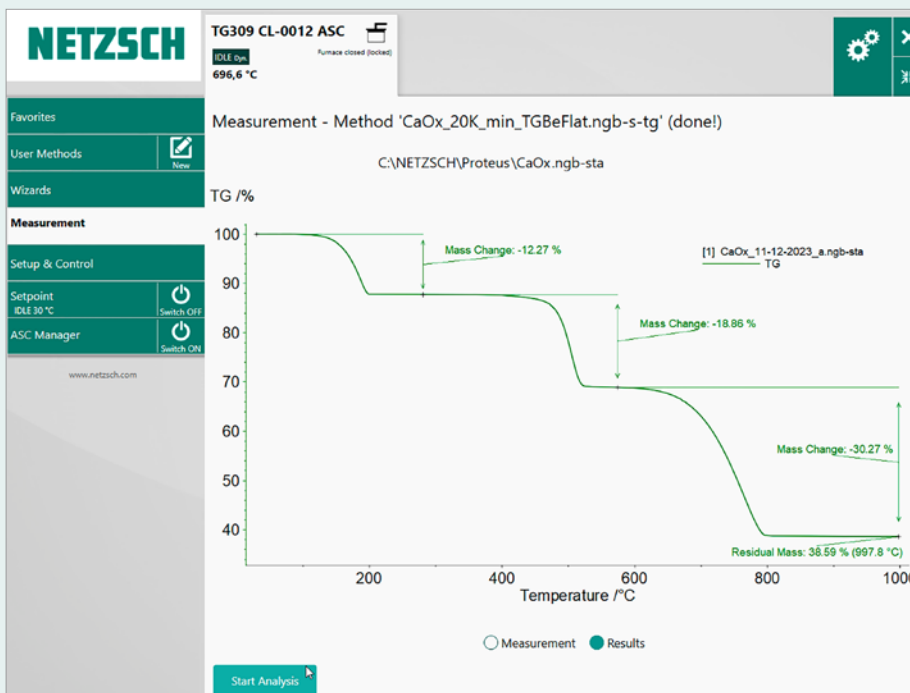

*SmartMode* –  
There's no need to be an expert in TGA to start a measurement!

# AutoEvaluation and Identify – Speed Up Results

## AutoEvaluation – Objective Results Right After a Measurement

*AutoEvaluation* is the first self-acting evaluation routine on the market and has been continuously improved. For thermogravimetry (TGA) measurements, it autonomously and instantly evaluates all significant mass changes (mass loss or mass gain). It also generates the derivative curve, DTG, and automatically evaluates the corresponding peak temperatures. When *AutoEvaluation* is incorporated into a measurement method, the evaluated TGA and DTG curves appear immediately after the measurement is completed. Users can customize the size of mass changes to be detected by *AutoEvaluation* and which evaluation results to display.

In general, *AutoEvaluation* results are time-saving and objective, because they are independent of the user. A great help for both beginners and experts!

Depicted here are the *AutoEvaluation* results from a measurement on a filled, styrene-based thermoplastic elastomer (TPS). The mass-loss step ranging from approximately 250°C to 400°C is likely caused by the evaporation of a plasticizer, whereas the mass-loss step between around 400°C and 500°C signifies the decomposition of the polymer content. The mass-loss step ranging from around 650°C to 750°C results from the decomposition of carbonate (filler).

## Identify – The Database for Material Identification and Quality Control

*Identify* is a unique software tool in the field of thermal analysis for the identification and classification of materials. Besides 1:1 comparisons with individual database measurements or literature data, it is also possible to compare a measurement with classes (groups of measurements or literature data). Such classes can consist of data of the same material type, allowing for material identification. A class can also contain reference curves for pass/fail testing in quality control.

The included NETZSCH libraries contain more than 1300 entries from the application areas of polymers, organics, pharmaceuticals, food, cosmetics, inorganics, ceramics, metals and alloys. Signal types currently supported include DSC, DSC  $c_p$ , TGA, STA, DIL/TMA and DMA. Users can expand the database with libraries containing an unlimited amount of their own data. Ultimately, this growing collection of database entries and measurement conditions can also be extremely useful in preparing future experiments.

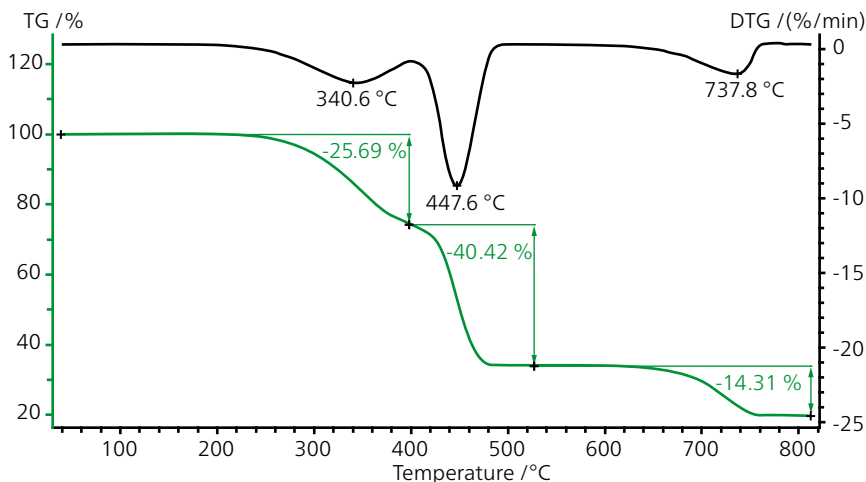

TGA measurement on a filled, styrene-based thermoplastic elastomer (TPS, 9.92 mg), heating rate 10 K/min, under a nitrogen atmosphere (40 ml/min) in an open  $Al_2O_3$  crucible. The DTG curve and all evaluations were carried out by *AutoEvaluation*.

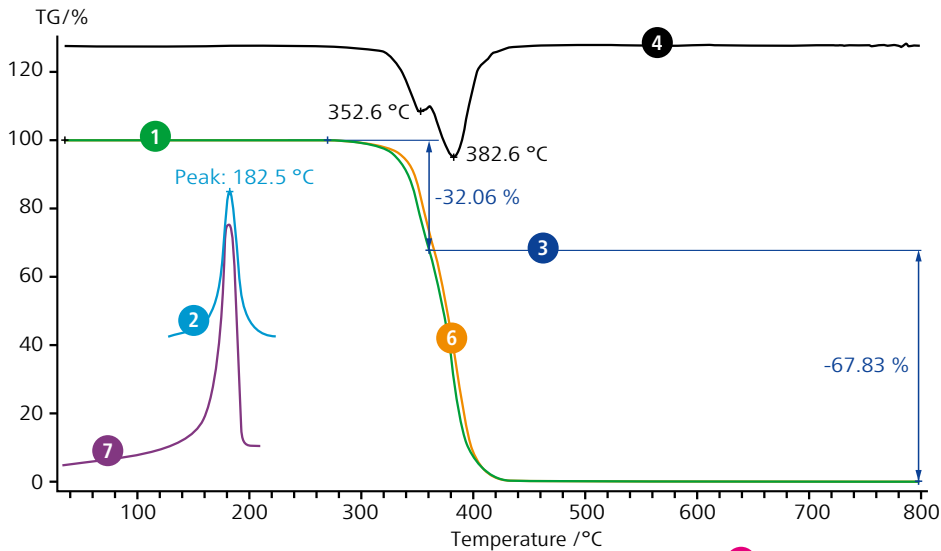

- ① TGA measurement curve of unknown material
- ② *c-DTA*<sup>®</sup> curve of unknown material
- ③ *AutoEvaluation* of TGA measurement
- ④ Automatic creation and evaluation of DTG curve
- ⑤ *Identify* results
- ⑥ TGA comparison curve from *Identify* database
- ⑦ DSC comparison curve from *Identify* database

Measurement/ Literature Data	Similarity [%]
POM-H_TGA	97.81
POM-H_DSC	62.21
PVDF_DSC	52.49
POM-C_DSC	48.21
PMMA_TGA	43.41
PP_DSC	42.95
PC-PBT_TGA	42.67
PLA_TGA	42.08
TPU_DSC	39.56
ACM_TGA	26.54

It is particularly advantageous that *Identify* can even simultaneously incorporate two types of measurements, such as TGA and DSC or *c-DTA*<sup>®</sup>, during identification, this can significantly reduce multiple interpretations, and thus increase the chances of correct material identification<sup>1</sup>. As shown in the example, the evaluated TGA and *c-DTA*<sup>®</sup> curves can be used together by *Identify*: Analysis reveals that the TGA decomposition result is very similar to that of the POM-H polymer found in the database; also, there is a DSC curve for POM-H that agrees well with the melting effect at a peak temperature of 183°C, which is also reflected in the *c-DTA*<sup>®</sup> curve of the input measurement. The material is thus identified as POM-H material with high confidence; all other polymer types present in the database can be ruled out.

<sup>1</sup> A. Schindler, M. Doedt, S. Gezgin, J. Menzel, S. Schmolzer, J Therm Anal Calorim (2017) 129:833–842, DOI 10.1007/s10973-017-6208-5



## Measurement Update in Passing – LED Status Bar

The TG 309 *Libra*® provides an LED light bar that allows you to check the status of your instrument as you walk by, with different colors representing different statuses. It is reassuring to see from afar, without having to log into your PC, that your measurement is running smoothly and to be able to read instrument status notifications such as:

- Instrument is ready
- Measurement is running
- Measurement progress
- Heating/Cooling to setpoint
- User interaction needed
- An issue arose

## Improving Your Productivity and Workflow Using the New User Interface

The integrated color display allows for the starting of a measurement that was previously prepared in the NETZSCH *Proteus*® software. Just touch the prepared measurement button on the display and you will be informed about the setup of the measurement. This moves the final check before you start a new measurement directly onto the instrument.

The color touch display offers:

- Start measurements with the touch of a finger
- Check recently finished measurements
- See the progress of your measurement and time remaining
- Check current temperature
- Check and change gas flow and gas inlet points
- Tare balance signal directly on the display
- Start and check *AutoVac* cycles
- Monitor pressure level of the balance vessel



Supervising your measurement made easy; monitor measurement progress, control and configure Setpoint and gas flow.

## Simplified Measurement Monitoring

*PLACING INSTRUMENT CONTROL AND INFORMATION DIRECTLY ONTO THE INSTRUMENT*

Get a clear, real-time view of the measurement progress

- Easily monitor the progress of your measurements and stay informed about the current temperature and gas flow
- Tare the TGA balance signal without logging into the computer
- Evacuation information is clearly displayed on the instrument

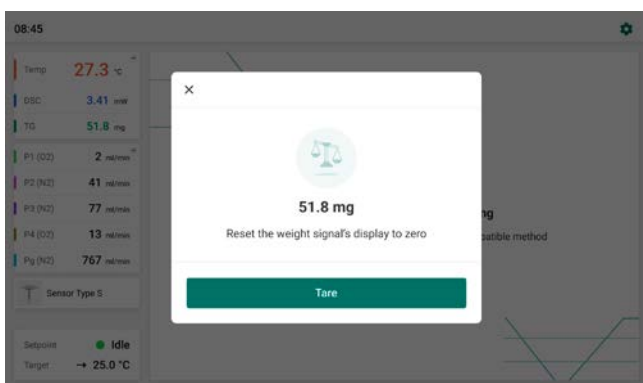

Taring the TGA balance signal

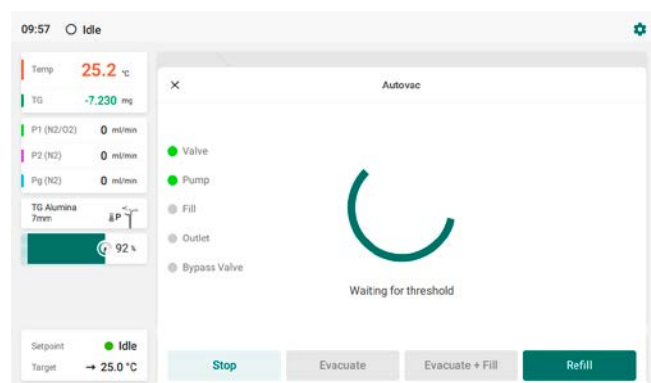

Information about the evacuation process

# FOCUS ON EFFICIENCY AND A MORE SUSTAINABLE LABORATORY

## Eco Mode – Uses Energy Only when Needed

To obtain accurate thermogravimetric results with low drift, a thermostat is used to condition the instrument. A constantly running thermostat not only consumes energy, but also produces waste heat that must be controlled by air conditioning systems.

On a busy day in the laboratory, the TGA instrument will be in use for around 10 to 12 hours. If no measurements are scheduled overnight or over the weekend, the instrument will either have to be shut down, resulting in a stabilization time before it can be used again, or it will remain on, consuming energy that is not technically required.

### Example of a Setpoint Eco/Idle Configuration

The screenshot shows a 'Setpoint Configuration' window with a 'Schedule' tab. It features a grid with columns for days of the week (Mon-Sun) and rows for hourly intervals from 00:00 to 23:00. The cells are colored green for 'ECO' and blue for 'IDLE'. The schedule shows the instrument in Eco Mode from 00:00 to 05:00, Idle Mode from 06:00 to 17:00, and Eco Mode from 18:00 to 23:00. Below the grid are buttons for 'Set Idle' and 'Set Eco', and a legend indicating that blue represents 'Instrument in Idle Mode' and green represents 'Instrument in Eco Mode'. There are also 'OK' and 'Abbrechen' buttons at the bottom.

	Mon	Tue	Wed	Thu	Fri	Sat	Sun
00:00	ECO	ECO	ECO	ECO	ECO	ECO	ECO
01:00	ECO	ECO	ECO	ECO	ECO	ECO	ECO
02:00	ECO	ECO	ECO	ECO	ECO	ECO	ECO
03:00	ECO	ECO	ECO	ECO	ECO	ECO	ECO
04:00	ECO	ECO	ECO	ECO	ECO	ECO	ECO
05:00	ECO	ECO	ECO	ECO	ECO	ECO	ECO
06:00	IDLE	IDLE	IDLE	IDLE	IDLE	ECO	ECO
07:00	IDLE	IDLE	IDLE	IDLE	IDLE	ECO	ECO
08:00	IDLE	IDLE	IDLE	IDLE	IDLE	ECO	ECO
09:00	IDLE	IDLE	IDLE	IDLE	IDLE	ECO	ECO
10:00	IDLE	IDLE	IDLE	IDLE	IDLE	ECO	ECO
11:00	IDLE	IDLE	IDLE	IDLE	IDLE	ECO	ECO
12:00	IDLE	IDLE	IDLE	IDLE	IDLE	ECO	ECO
13:00	IDLE	IDLE	IDLE	IDLE	IDLE	ECO	ECO
14:00	IDLE	IDLE	IDLE	IDLE	IDLE	ECO	ECO
15:00	IDLE	IDLE	IDLE	IDLE	IDLE	ECO	ECO
16:00	IDLE	IDLE	IDLE	IDLE	IDLE	ECO	ECO
17:00	IDLE	IDLE	IDLE	IDLE	IDLE	ECO	ECO
18:00	ECO	ECO	ECO	ECO	ECO	ECO	ECO
19:00	ECO	ECO	ECO	ECO	ECO	ECO	ECO
20:00	ECO	ECO	ECO	ECO	ECO	ECO	ECO
21:00	ECO	ECO	ECO	ECO	ECO	ECO	ECO
22:00	ECO	ECO	ECO	ECO	ECO	ECO	ECO
23:00	ECO	ECO	ECO	ECO	ECO	ECO	ECO

Sustainability in the laboratory environment is becoming increasingly important.<sup>1</sup>

The TG 309 *Libra*® offers an energy-saving Eco Mode, which allows the chiller to be switched off automatically via software, making it much more economical to run.

The software provides a user-defined schedule to activate either Idle or Eco Mode. This eliminates the waiting time that would occur if the instrument was completely shut down, by reactivating the gas flow and thermostat as required, so that the instrument is ready for the first measurement on schedule.

Switching the unit to Eco Mode will save 1 kW of electricity, which can sum up to over 6000 kWh per year. This makes the instrument cheaper to run and effortlessly reduces your carbon footprint.

<sup>1</sup> <https://www.rsc.org/globalassets/22-new-perspectives/sustainability/sustainable-labs/sustainable-laboratories-report.pdf>

- Instrument in Idle Mode
- Instrument in Eco Mode



NETZSCH instruments are compatible with the LabV® data management platform, a user-friendly software that automates data collection, regardless of method or device, and provides a centralized view for organizing, analyzing, and exploring your data. LabV®'s AI-powered

digital assistant simplifies data analysis, allowing labs to easily find insights with no effort. It uses natural language processing, similar to ChatGPT, making it easy for labs to create visualizations, spot trends, and uncover complex correlations with straightforward commands.



# ADDITIONAL SOFTWARE CAPABILITIES

## Proteus® Search Engine

When dealing with measurement and evaluation data from different materials and obtained through different measurement setups, the ability to filter based on specific criteria is incredibly beneficial. *Proteus® Search Engine* provides fast and sophisticated filtering of your measurement data in seconds, serving as a powerful data management tool. Following the selection process, it automatically provides previews of measurements or analysis states. It also simplifies the process of opening folders in the file system by allowing this with a single click. Users have the flexibility to create personalized searches, such as “MyPolymers”, and easily switch between existing searches as needed.

## Report Generator

Each operator can easily create their own report templates – including logos, tables, description fields and plots. Several report examples are already included as templates in the *Proteus®* software. Results derived from *Identify* searches can also be included in reports.

## Peak Separation for Improved Determination of Overlapping Mass-Loss Steps

If your experimental curve exhibits complexity, featuring overlapping mass-loss steps, know that our software is designed to assist in the separation of these peaks. It facilitates the presentation of experimental data as a sum of individual peaks and enables analysis of each peak separately.

## Kinetics Neo – Process Optimization by Prediction

Kinetics Neo creates kinetic models of decomposition and evaporation processes based on a series of measurements under different temperature conditions. With the powerful NETZSCH Kinetics Neo software, even multi-step processes can be precisely modelled. Kinetic parameters such as activation energy, pre-exponential factor and order of reaction can be determined. Kinetics Neo can be used to predict the behavior of chemical systems under user-defined conditions for process optimization.

Software Features			
	Classic	Select	Supreme
<i>ExpertMode</i>	■	■	■
<i>SmartMode</i>	■	■	■
<i>AutoCalibration</i>	■	■	■
<i>AutoEvaluation</i>	■	■	■
Predefined Methods	■	■	■
TGA-BeFlat®*	■	■	■
<i>c-DTA®</i>	■	■	■
Report Generator	■	■	■
Eco Mode	■	■	■
<i>Identify</i>	□	■	■
<i>Proteus® Search Engine</i>	□	□	■
<i>Peak Separation</i>	□	□	■
Temperature-modulated TGA (TM-TGA)	□	□	■
<i>SuperRes®</i>	□	□	■
LabV®	□	□	□
LIMS Support	□	□	□
<i>Proteus® Protect</i> (CFR 21 part 11)	□	□	□
Kinetics Neo	□	□	□
Termica Neo**	□	□	□
EGA support	N/A	□	□

■ included

□ optional

\* included when MFC is selected

\*\* requires Kinetics Neo

More features on request.

# APPLICATION FIELDS

## Plaster with Fire Protection Properties

The TGA analysis of plaster with fire protection properties shows seven decomposition steps during heating. With the help of mass spectrometry coupling, the evolved gases were identified during decomposition. The 1<sup>st</sup> mass-loss step was caused by the release of water (m/z 18); the 2<sup>nd</sup> and 3<sup>rd</sup> were caused by the decomposition of organic compounds (m/z 38, 40 and 55). Between 500°C and 800°C, the release of CO<sub>2</sub> (m/z 44) was detected, probably due to the decomposition of carbonates. The last mass-loss step can be traced back to decomposition of sulphates, as SO<sub>2</sub> (m/z 64) was released.

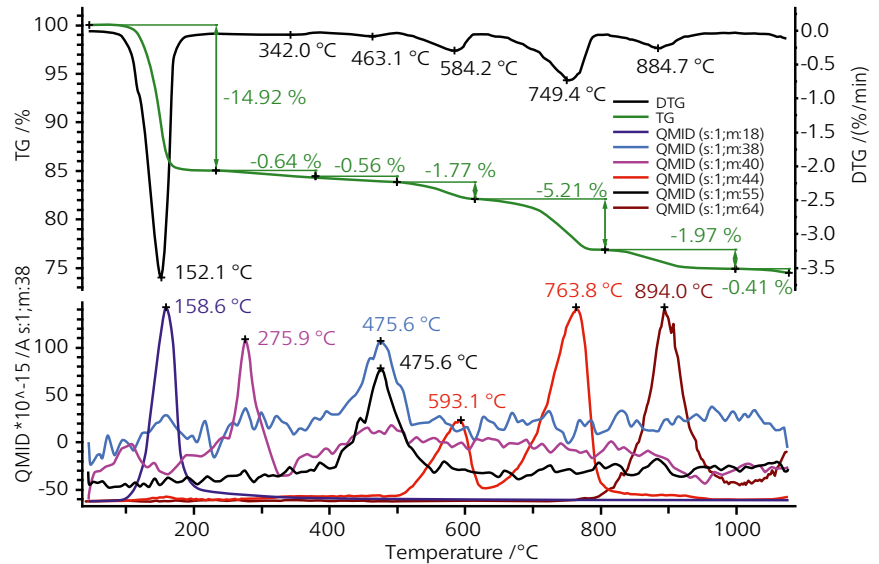

TGA-MS measurement on plaster in an inert atmosphere, 10 K/min, sample mass 40 mg; TGA curve (green), DTG (black), mass numbers ion current of mass m/z 18, 38, 40, 44, 54 and 64

## Composition of Bicycle Tire Casing

TGA for the compositional analysis of rubber is a widely used application (ISO 9924 or ASTM E1131). In this example, a bicycle tire casing was investigated. The 1<sup>st</sup> mass-loss step refers to the plasticizer content, which is 8.7%. The subsequent two degradation steps of the rubber components can be separated precisely. Even low content levels of inorganic fillers such as chalk can be determined by TGA. The mass-loss step at 664.5°C (DTG peak) with a mass loss of only 1.2% can be attributed to the release of CO<sub>2</sub> resulting from the decomposition of chalk (CaCO<sub>3</sub>). By switching to an oxidizing atmosphere at 850°C and further heating to 1100°C, combustion of the carbon black can be observed and quantified.

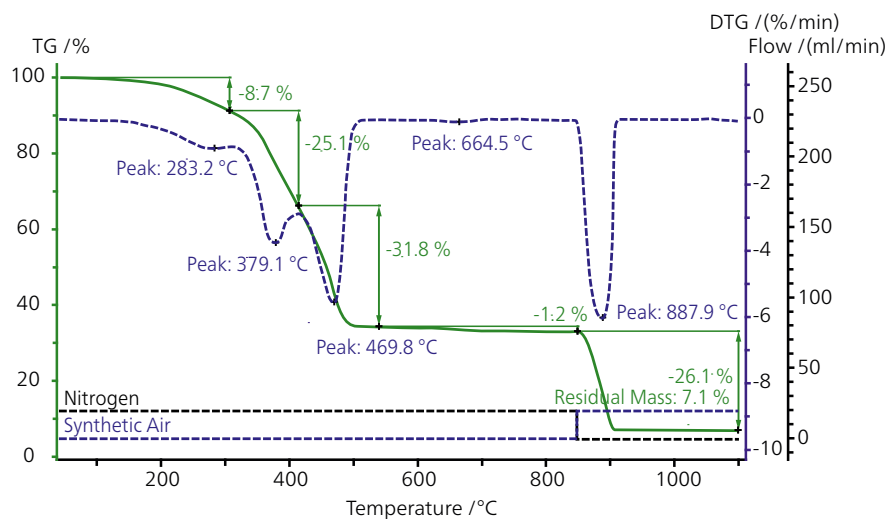

TGA measurement on bicycle tire casing, heating rate 10 K/min, sample mass 9.79 mg, TGA curve (green line), DTG curve (blue dashed)



## Walnut Shell

Biomass can be used as a renewable energy resource to produce syngas or chemical precursors, and to produce pure carbon. This example shows the proximate analysis of a walnut shell sample. During the drying step at 110°C, 4.1% of humidity was released. Heating to 800°C in an inert atmosphere resulted in two overlapping pyrolysis steps of 64.5%. During these steps, the organic components were decomposed. After switching to an air atmosphere, the carbon content of 27.9% was burned to CO<sub>2</sub>. The ash content was determined using the residual mass of 3.4%.

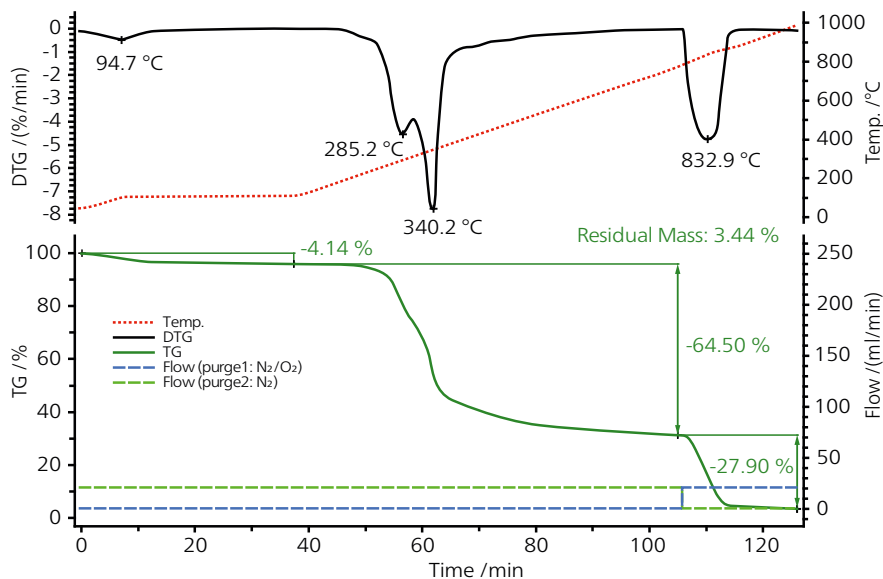

Proximate analysis of walnut shell: TGA curve (green), DTG curve (black), temperature profile (red dotted).

## Different Hydrate Forms of Naproxen Sodium

Naproxen sodium is an active pharmaceutical ingredient (API) used to treat pain of various origins and inflammation. It can exist as anhydrate, monohydrate, two types of dihydrate and tetrahydrate.

During heating at a heating rate of 10 K/min, first a mass loss of 4.22% occurs at 75°C (DTG peak) which is caused by the release of water ( $m/z = 18$  with a peak at 84°C, blue curve). This is less than the theoretical mass loss of a monohydrate sample (6.7%) calculated from stoichiometry. Slightly above 300°C, naproxen sodium starts to decompose, resulting in the formation of water ( $m/z = 18$ ), CO<sub>2</sub> ( $m/z = 44$ ) and a hydrocarbon fragment with  $m/z = 171$ , which leads to a further mass loss of almost 50% in the temperature range up to 600°C.

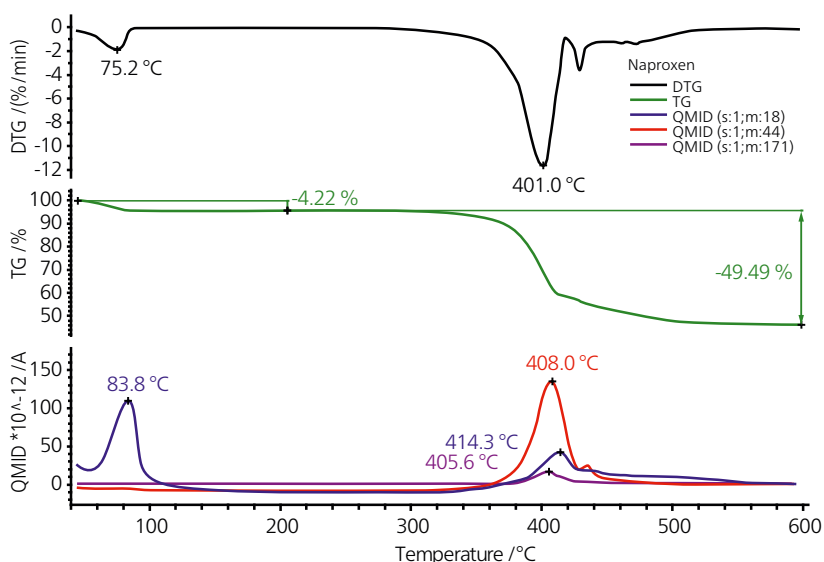

TGA-MS measurement on naproxen in an inert atmosphere, heating rate 10 K/min, sample mass 10 mg, TGA curve (green), DTG (black), ion current of masses  $m/z$  18, 44 and 171

# Expanding Thermal Analysis Capabilities with Hyphenated Techniques

Thermogravimetric analysis is a universal tool for characterizing solids and liquids, but what is lacking is chemical and analytical information about the course of events causing the mass change in the sample. Evolved Gas Analysis (EGA) by such techniques as quadrupole mass spectrometry can supply this additional information.

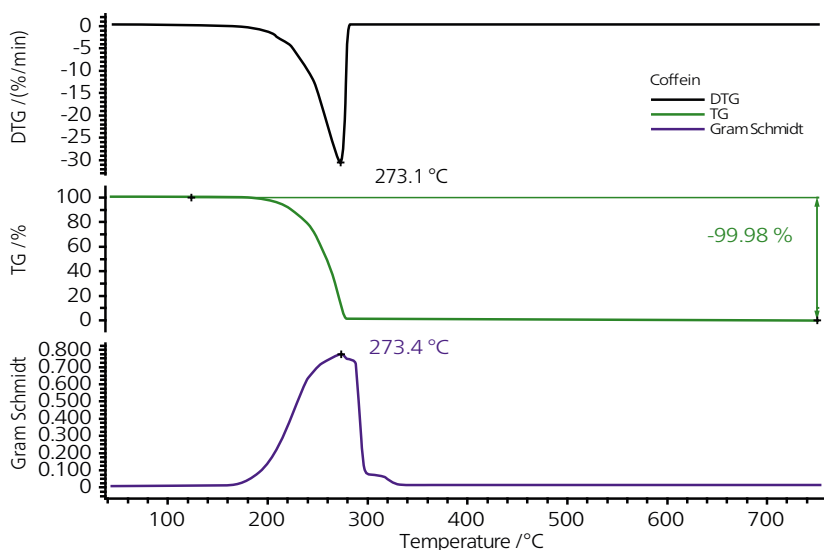

TGA-FT-IR measurement: TGA curve (green), DTG curve (black) and Gram-Schmidt curve (purple) in a nitrogen atmosphere from RT to 750°C at 10 K/min

## Evaporation of Caffeine Measured by TGA-FT-IR

The high interface temperatures of the coupling adapter, transfer line and FT-IR gas cell of 370°C enable the detection of caffeine evaporation without decomposition or tailing.

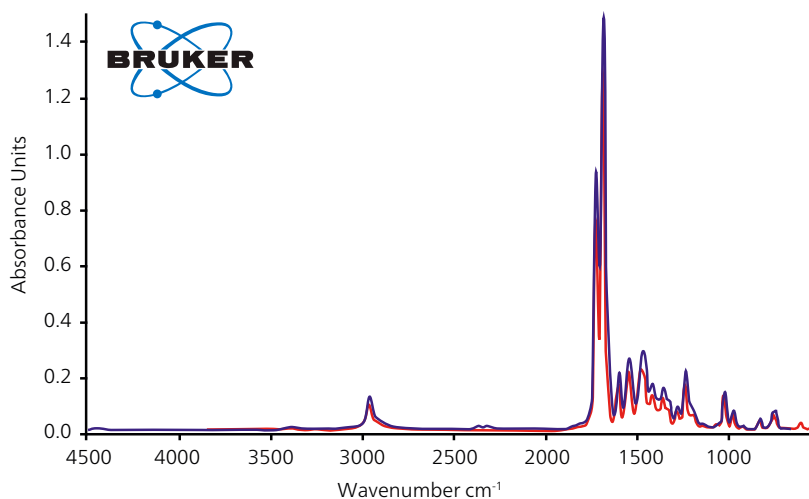
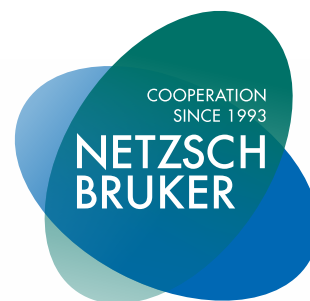

Measured spectrum at 285°C (blue) and library spectrum of caffeine (red).



Bruker INVENIO FT-IR spectrometer

External TGA-IR box up to 370°C

# Using Mass Spectroscopy to Optimize Battery Performance

## Determination of Different Carbon Types in Battery Anode Material

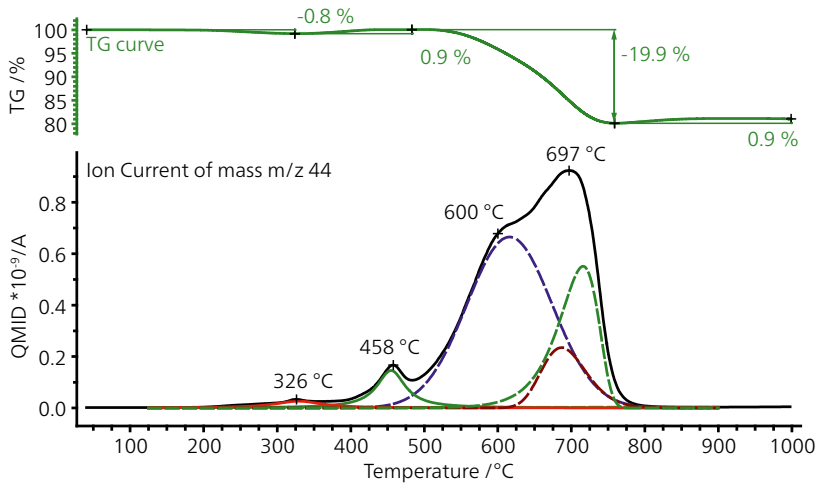

Measurement of an anode material on copper foil (26 mg), heating rate 10 K/min under a synthetic air atmosphere, TGA curve (green), ion current of mass  $m/z$  44 curve (black)



Understanding the carbon composition within anode materials is critical to optimizing battery performance. This example shows an analysis of an anode material suitable for batteries deposited on a copper foil. Using a combination of thermogravimetric analysis and mass spectrometry, it was possible to monitor the oxidation of the copper foil along with the decomposition of various carbon structures such as graphite, carbon black, graphene, and carbon nanotubes. The correlated CO<sub>2</sub> emission serves as a valuable indicator that encapsulates information about the different types of carbon structures present in the anode material.

### Use of Peak Separation

Use of the *Peak Separation* functionality embedded in *Proteus*<sup>®</sup> analysis provides a unique solution capable of resolving complex and overlapping peak shapes. Applying this innovative tool to the CO<sub>2</sub>  $m/z$  44 emission data allows for the differentiation of different carbon types based on their particle size variations and associated decomposition temperatures. This software feature facilitates the precise identification and differentiation of carbon species, refining our understanding of their role within material composition.



TG 309 Libra<sup>®</sup> Supreme

QMS 403 Aëolos<sup>®</sup> Quadro up to 350°C

# Overview: Evolved Gas Analysis (EGA) Extensions for the TG 309 *Libra*®

By coupling the TG 309 *Libra*® to a gas analysis technique such as FT-IR (Fourier Transform Infrared), MS (Mass Spectrometry) or GC-MS (Gas Chromatography – Mass Spectrometry), information about the nature of the evolved gases as a function of time or temperature can be obtained, providing a fingerprint of the material being analyzed.

## Coupling to FT-IR

“More than just the sum of its parts” is the slogan for our comprehensive coupling system incorporating an FT-IR (Fourier Transform Infrared) spectrometer manufactured by our collaborative partner, Bruker Optics.

The purge gas flow from the TGA carries the volatiles through a short heated transfer line to the vacuumtight gas cell of the FT-IR.

All evolved gases with a changing dipole moment are identified by their typical absorption spectrum, and complex gas mixtures can be spectroscopically separated.

## PERSEUS TG 309 *Libra*®

The *PERSEUS* TG 309 *Libra*® constitutes a TGA-FT-IR system incorporating compact Bruker Optics FT-IR spectrometer in an excellent alliance.

The design integrating the two systems has set a whole new benchmark in state-of-the-art coupling techniques. The built-in heated gas cell is directly connected with the gas outlet of the TGA furnace, and the low volume of the short transfer path enables fast transport while maintaining a small instrument footprint.

## Coupling to MS

High-level material research and characterization can be achieved by coupling the TG 309 *Libra*® to our QMS 403 *Aëolos*® Quadro quadrupole mass spectrometer. Any gases evolved are introduced directly into the electron impact ion source of the MS through a quartz glass capillary heated to 300°C.

## Coupling to GC-MS

GC is a high-resolution technique for volatile and semi-volatile compounds. The gas mixtures are separated on the basis of differences in the component distribution between a stationary phase (e.g., inner coating of a capillary and a mobile capillary) and a mobile phase (purge gas; e.g., helium).

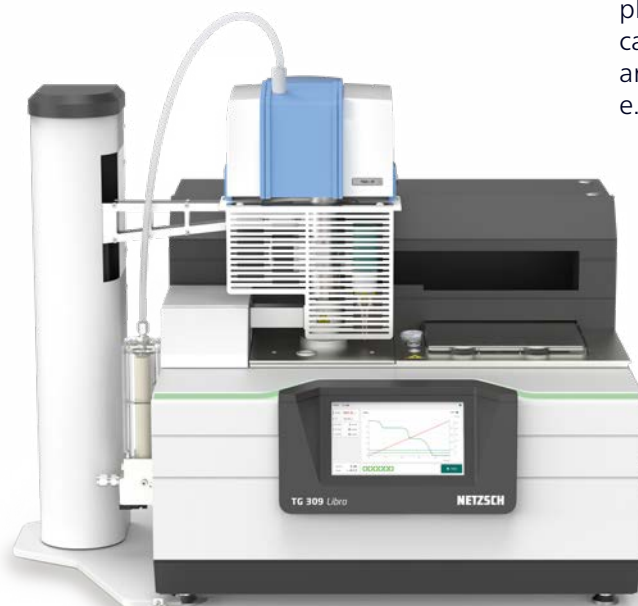

*PERSEUS* TG 309 *Libra*®

# Technical Specifications

TG 309 Libra®			
	Classic	Select	Supreme
Temperature range	(10°C) RT to 1025°C	(10°C) RT to 1025°C/1100°C	(10°C) RT to 1100°C
Heating rate	0.001 K/min to 200 K/min	0.001 K/min to 200 K/min	0.001 K/min to 200 K/min
Balance resolution	50 ng	20 ng	10 ng
Cooling time <sup>1</sup>	In nitrogen: ≈ 12 min from 1100°C to 100°C In helium: ≈ 5 min from 1100°C to 100°C, ≈ 10 min to 25°C		
Max. sample weight/ measuring range	2 g (including crucible)	2 g (including crucible)	2 g (including crucible)
<i>AutoVac</i>	Automatic evacuation and refilling of purge gas; optionally available if MFC is selected		
Temperature resolution	0.001 K	0.001 K	0.001 K
Temperature accuracy <sup>2</sup>	± 0.3 K (after calibration by c-DTA®, indium)		
Temperature calibration	c-DTA®, also for detection of endo- and exothermal effects; Curie standards		
Temperature stability <sup>3</sup>	Peak-to-peak: 0.03 K RMS: 0.005 K	Peak-to-peak: 0.03 K RMS: 0.005 K	Peak-to-peak: 0.03 K RMS: 0.005 K
Temperature precision <sup>4</sup>	0.15 K	0.15 K	0.15 K
Vacuum-tightness	1 mbar	<< 10 <sup>-1</sup> mbar	<< 10 <sup>-1</sup> mbar
Integrated 4-fold MFC	<input type="checkbox"/>	<input type="checkbox"/>	<input checked="" type="checkbox"/>
Integrated 3-fold MFC	<input type="checkbox"/>	<input type="checkbox"/>	-
Evolved Gas Analysis	-	<input type="checkbox"/>	<input type="checkbox"/>
192+12-position ASC	-	<input type="checkbox"/>	<input type="checkbox"/>
20-position ASC	<input type="checkbox"/>	-	-
Piercing device	-	<input type="checkbox"/>	<input type="checkbox"/>
Color touch display	<input type="checkbox"/>	<input checked="" type="checkbox"/>	<input checked="" type="checkbox"/>
Unlimited warranty <sup>5</sup>	<input type="checkbox"/>	<input type="checkbox"/>	<input type="checkbox"/>

1 21°C chiller temperature, 200 ml/min He (purge + protective gas); the maximum temperature of the TGA system depends on the He gas flow: at 200 ml/min, T<sub>max</sub> is 1020°C.

2 Maximum deviation between measured and literature value (indium)

3 Measurement at different isothermal temperatures

4 Standard deviation based on 10 measurements

5 In connection with maintenance contract

included  
 optional

The NETZSCH Group is an owner-managed, international technology company with headquarters in Germany. The Business Units Analyzing & Testing, Grinding & Dispersing and Pumps & Systems represent customized solutions at the highest level. A worldwide sales and service network ensure customer proximity and competent service.

Our performance standards are high. We promise our customers Proven Excellence – exceptional performance in everything we do, proven time and again since 1873.

When it comes to Thermal Analysis, Calorimetry (adiabatic & reaction), the determination of Thermophysical Properties, Rheology and Fire Testing, NETZSCH has it covered. Our 60 years of applications experience, broad state-of-the-art product line and comprehensive service offerings ensure that our solutions will not only meet your every requirement but also exceed your every expectation.

# Proven Excellence. ■

NETZSCH-Gerätebau GmbH  
Wittelsbacherstraße 42  
95100 Selb, Germany  
Tel.: +49 9287 881-0  
Fax: +49 9287 881-505  
at@netzsch.com  
[www.analyzing-testing.netzsch.com](http://www.analyzing-testing.netzsch.com)



**NETZSCH**®

[www.netzsch.com](http://www.netzsch.com)