

**NETZSCH**

Proven Excellence.

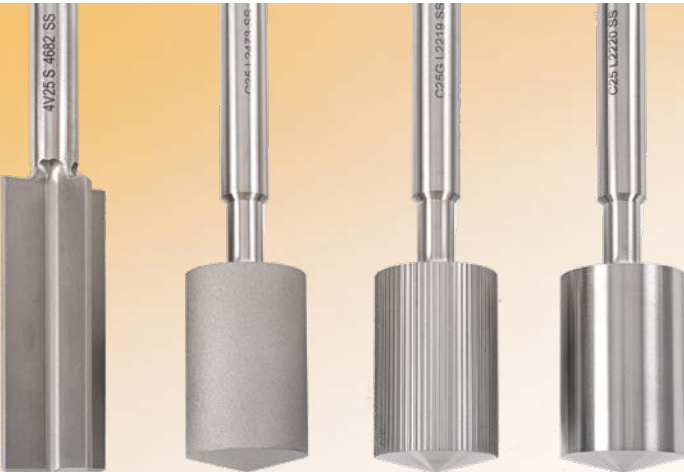

### Accessories for Kinexus Rheometers

Environmental Controllers, Plates, Cups, Bobs  
and Special Accessories

Analyzing & Testing

# Introduction

## Kinexus Rheometer Series

The Kinexus series of rotational rheometers are class-leading instruments, possessing custom air bearings which are incredibly sensitive to measuring small material differences. The exceptional torque sensitivity provides the ability to measure materials under 'at rest' conditions, enabling determination of product performance such as stability and shelf-life. The unique axial capabilities of Kinexus provides further insight into your material properties. The modular design, combined with it's intelligent software provides you with a user friendly, interactive experience.

## Accessories for Kinexus Rheometer Series

The Kinexus rotational rheometers are designed as multifunctional solutions which are easily adapted to suit your needs, addressing a wide range of applications.

The wide variety of measurement geometries are optimized for rheological characterization of complex fluids and soft solids, including dispersions, emulsions, polymer and surfactant solutions, pastes and gels.

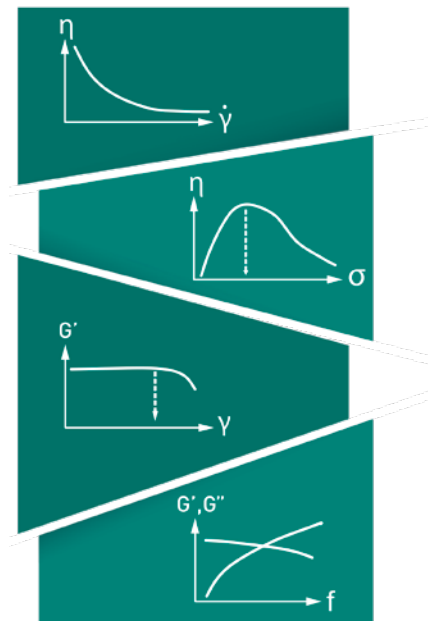

# TABLE OF CONTENTS

## Environmental Controllers

Peltier Plate Cartridge .....	4
Active Hood Cartridge .....	5
Peltier Cylinder Cartridge .....	6
High Temperature Cartridge Prime .....	7

## Parallel Plates

Upper Parallel Plates .....	9
Lower Parallel Plates .....	12

## Upper Cones

.....	14
-------	----

## Cups and Bobs

Bobs .....	19
Double Gap Bob and Sets .....	20
Vane tools .....	21
Cups .....	22
Plate Inserts .....	23

## Verification and Spare Parts

Verification .....	24
Spare Parts .....	24

## Special Accessories

Solvent Trap .....	26
Universal Container Holder .....	27
Texture Analysis .....	28
Disposable Plates .....	30
Tack Test Option .....	32
DMA Accessories .....	33
Tribology .....	35
UV Curing System .....	37
Twin Orbital Ball .....	39
Crumb Rubber Kit .....	41
Rheo-Microscope .....	42
Rheology of Dispersions – Starch Pasting Cell .....	44
Rheology of Dispersions – Twin Dispersion Paddle .....	45
Du-Nouy Ring .....	46
Interfacial Rheology – Bi-Cone .....	47
Immersion Cell .....	48
Immobilization Cell .....	49
Mooney Ewart .....	50

Environmental  
Controllers

Parallel Plates

Upper Cones

Cups and Bobs

Verification  
and Spare Parts

Special Accessories

# EasySwap Temperature Cartridges

Designed for the Rheological Testing of Complex Fluids and Soft Solids

- All *EasySwap* cartridges are compatible with the complete Kinexus suite of rotational rheometers
- Unique plug and play cartridge design
- Quick, easy and robust insertion
- Featuring mechanical, power, communication and fluid connections in one action
- Automatic cartridge recognition and configuration
- Peltier-based systems provide high heating and cooling rates with excellent temperature stability
- High accuracy temperature sensor in close proximity to the sample
- Temperature resolution to 0.01°C
- Easy-to-clean designs

## Peltier Plate Cartridge

Environmental controller for cone-plate and parallel plate measuring systems

- Temperature range: -5°C to 200°C, or from - 40°C with active heat exchanger
- Meets the temperature control requirements for a wide range of applications from fluids such as water-like samples to soft solids, such as putty or elastomers
- Interchangeable lower plates enable optimal geometry choice, e.g., matching lower pedestal diameter for self-supporting samples, without compromising thermal performance
- Efficient solvent trap design for accurate measurement of samples with volatile components and to minimize sample drying
- Disposable plate option for curing materials

Peltier Plate Cartridge		
Name	Remarks	Order Number
Entry Level Peltier Plate Cartridge	Maximum temperature of 150°C	KNX2001-E
Peltier Plate Cartridge	Maximum temperature of 200°C	KNX2001



# Active Hood Cartridge

The best temperature control system designed to eliminate thermal gradients

- Temperature range: -5°C to 180°C, or from -40°C with active heat exchanger
- Applicable for measuring highly thermal sensitive samples, including temperature critical testing where the temperature range is significantly above or below ambient
- Proprietary design combines Peltier elements with additional heaters to actively control radial and vertical thermal losses, from the local sample environment
- Low thermal mass components for rapid response
- Inlet for inert gas feed into sample environment
- Resolution 0.01°C, stability better than +/- 0.1°C
- Interchangeable lower plates enable optimal geometry choice, e.g. matching lower pedestal diameter for self-supporting samples, without compromising thermal performance
- Disposable plate option for curing materials

Active Hood Cartridge		
Name	Remarks	Order Number
Entry Level Active Hood Cartridge	Maximum temperature of 150°C	KNX2007-E
Active Hood Cartridge	Maximum temperature of 180°C	KNX2007-X



# Peltier Cylinder Cartridge

## Environmental controller for concentric cylinder-type measuring systems

- Temperature range: 0°C to 200°C, or from -25°C with active heat exchanger
- Temperature control for materials from highly fluid-like samples through to high concentration yield stress dispersions
- Twin Peltier design for rapid temperature changes and sample equilibration and minimized thermal gradients
- Various cup and bob sizes are available – C14 (DIN), C25 (DIN) and wide diameter C34
- Double gap cell, Mooney Ewart and vane tools
- Optional interchangeable lower cups with removable base for ease of cleaning
- Universal Peltier option to enable parallel plate and cone and plate measurements

Peltier Plate Cartridge		
Name	Remarks	Order Number
Entry Level Peltier Cylinder Cartridge	Maximum temperature of 150°C	KNX2002-E
Peltier Cylinder Cartridge	Maximum temperature of 200°C	KNX2002



# High Temperature Cartridge Prime

Cutting-edge temperature control in HTC Prime, inspired by thermal analysis technology

- Temperature range: 5°C to 450°C
- Boost cooling for time-efficient sample management
- Homogeneous sample temperature distribution through optimized forced convection and conductive heating
- Smart cooling air control for perfect sample temperature homogeneity
- Thermally optimized design with low thermal mass and isolation
- Suitable for cone-plate and plate-plate geometries up to 40 mm in diameter, ability to purge with Nitrogen gas
- Active thermal management system

## HTC Prime

Name	Order Number
HTC Prime	RHR000KIA84.000-00





# Parallel Plates



Parallel Plates can be used for measuring a wide variety of materials from low viscosity liquids to such as more viscous samples: gel-like materials, soft solids, polymeric and reactive systems.

## Tips and Tricks

The simple flat upper and lower parallel plates are available in various materials, diameters and surface finishes, and are incredibly versatile.

- **Size** – ranging from 4 mm to 60 mm in diameter as standard. The wide range of plate sizes is available to accommodate materials with different viscosities. The smaller geometries are for suitable for high viscosity samples and the larger geometries (>50 mm), for low viscosity (<0.1 Pa-s) materials.
- **Surface finish** – can be smooth, roughened or serrated. Different surface finishes are available to accommodate those stubborn samples! Emulsions and slurries, for example, may be prone to slippage. This manifests itself as an early drop in viscosity during a shear rate measurement. If a sudden decrease in viscosity during a measurement occurs and slip is suspected, swap to using a geometry with a roughened surface finish. This modified surface interface provides extra grip to encourage the material to flow.
- **Measuring gap** – can be changed with parallel plates between 0.05 mm to greater than 2 mm in height. This flexible feature means that gaps can be tailored to match the samples' viscosity (i.e., smaller gaps for lower viscosity samples) and to achieve different shear rates. Smaller gaps subject samples to higher shear rates (for the same angular velocity), whilst larger gaps will only achieve lower shear rates. As a compromise for the modifiable gap with these measuring systems, an average shear rate is applied to the sample and therefore, results are not absolute (as with cones and plates). In addition, as a general rule of thumb, if particles are present, select a measuring gap of at least 10 times larger than the largest particles. An appropriate gap size will prevent jamming (and potential geometry damage) for larger, solid particles and also provides sufficient interactions to eliminate wall effects, which will cause artefacts in the results.
- **Materials** – the standard geometries on offer are made of stainless steel (SS316L) which is ideal for most laboratory environments as they are compatible with a wide range of sample types and can easily be cleaned with solvents. However, in some circumstances when working with acidic samples, a polymeric geometry such as PEEK or acrylic may be more suitable. The added advantage is that these are lighter and hence useful for high-frequency oscillation measurements on low-viscosity samples. In addition, titanium, aluminum and hastelloy steel geometries are also available.





# Upper Parallel Plates

Upper Parallel Plates with Smooth Surface		
Diameter (mm)	Material	Order Number
4	Stainless Steel	KNX0057
8	Stainless Steel	KNX2025
10	Stainless Steel	KNX2181
15	Stainless Steel	KNX2138
20	Stainless Steel	KNX2026
25	Stainless Steel	KNX2027
40	Stainless Steel	KNX2028
50	Stainless Steel	KNX2083
60	Stainless Steel	KNX2029
8	Titanium	KNX2276
20	Titanium	KNX2124
25	Titanium	KNX2211
40	Titanium	KNX2134
50	Titanium	KNX2169
40	PEEK	KNX0188
60	PEEK	KNX2311
40	Acrylic	KNX2307
60	Acrylic	KNX2308



### Upper Parallel Plates with Roughened (Sandblasted) Surface

Diameter (mm)	Material	Order Number
4	Stainless Steel	KNX0057-SB
8	Stainless Steel	KNX2025-SB
10	Stainless Steel	KNX2181-SB
15	Stainless Steel	KNX2138-SB
20	Stainless Steel	KNX2026-SB
25	Stainless Steel	KNX2027-SB
40	Stainless Steel	KNX2028-SB
60	Stainless Steel	KNX2029-SB
20	Titanium	KNX2124-SB



### Upper Parallel Plates with Serrated Surface

Diameter (mm)	Material	Order Number
8	Stainless Steel	KNX0142
20	Stainless Steel	KNX2030
25	Stainless Steel	KNX2163
40	Stainless Steel	KNX2031
50	Stainless Steel	KNX2164

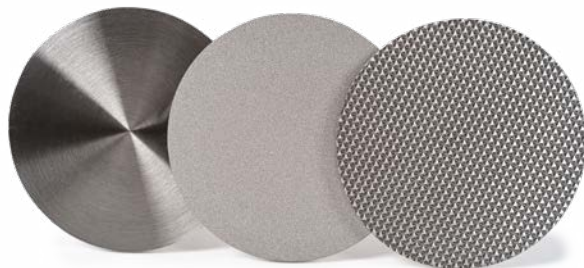

## Note

Materials in the tables shown are readily available to purchase. To enquire about a material not listed here, please contact your local sales representative.

The High Temperature Cartridge geometries are precision made from stainless steel 316 and incorporate a hollow section in the extended shaft to prevent heat transfer along their length. This makes them thermally safe even for longer high temperature tests.

### HTC Prime Upper Parallel Plates with Smooth Surface

Diameter (mm)	Material	Order Number
8	Stainless Steel	RHR000KIA50.206-00
15	Stainless Steel	RHR000KIA50.205-00
20	Stainless Steel	RHR000KIA50.204-00
25	Stainless Steel	RHR000KIA50.203-00
30	Stainless Steel	RHR000KIA50.202-00
35	Stainless Steel	RHR000KIA50.201-00
40	Stainless Steel	RHR000KIA50.200-00



### Upper Parallel Plates with Shear Position 100 % Design meets US AASHTO T315-12 Specification for Asphalt.

Standard length	Order Number
4 mm	RHR000KIA50.208-00
8 mm	RHR000KIA50.209-00
25 mm	RHR000KIA50.210-00
HTC Prime length	Order Number
4 mm	RHR000KIA50.211-00
8 mm	RHR000KIA50.212-00
25 mm	RHR000KIA50.212-00

# Lower Parallel Plates

Lower Plates with Smooth Surface				
Diameter (mm)	Solvent Trap Ring?	Material	Remarks	Order Number
4	No	Stainless Steel		KNX0058
8	No	Stainless Steel	Design meets US AASHTO T315-12 Specification for Asphalt Binder Testing	KNX0016
10	Yes	Stainless Steel		KNX0251
20	Yes	Stainless Steel		KNX0117
20	No	Stainless Steel		KNX0015
25	No	Stainless Steel	Design meets US AASHTO T315-12 Specification for Asphalt Binder Testing	KNX0014
40	Yes	Stainless Steel		KNX0119
50	Yes	Stainless Steel		KNX0076
55	Yes	Stainless Steel		KNX0101
60	Yes	Stainless Steel		KNX0114
60	Yes	Stainless Steel	A special design with only 1 outer location ring for use with solvent trap	KNX0221
61	Yes	Stainless Steel		KNX0113
65	No	Stainless Steel		KNX0011
70	No	Stainless Steel		KNX0125



Lower Plate (40 mm) with smooth surface (KNX0119)



Alternative Material Lower Plates with Smooth Surface			
Diameter (mm)	Solvent Trap Ring?	Material	Order Number
65	No	Titanium	KNX2170
60	Yes	PEEK	KNX0159

## Lower Plates with Roughened (Sandblasted) Surface

Diameter (mm)	Solvent Trap Ring?	Material	Order Number
4	Yes	Stainless Steel	KNX0058-SB
8	Yes	Stainless Steel	KNX0016-SB
20	Yes	Stainless Steel	KNX0120
25	No	Stainless Steel	KNX0014-SB
25	Yes	Stainless Steel	KNX0268-SB
40	No	Stainless Steel	KNX0119-SB
50	Yes	Stainless Steel	KNX0076-SB
60	Yes	Stainless Steel	KNX0114-SB
61	Yes	Stainless Steel	KNX0118
65	No	Stainless Steel	KNX0011-SB

## Lower Plates with Serrated Surface

Diameter (mm)	Solvent Trap Ring?	Material	Order Number
8	Yes	Stainless Steel	KNX0143
8	No	Stainless Steel	KNX0044
20	Yes	Stainless Steel	KNX0123
25	Yes	Stainless Steel	KNX0045
35	No	Stainless Steel	KNX0043
40	Yes	Stainless Steel	KNX0122
40	No	Stainless Steel	KNX0018
50	Yes	Stainless Steel	KNX0104
50	No	Stainless Steel	KNX0042
61	Yes	Stainless Steel	KNX0121
65	No	Stainless Steel	KNX0070

## Extra Large Lower Cups for Plate Cartridge

Diameter x Height (mm)	Solvent Trap Ring?	Material	Remarks	Order Number
50 x 75	N/A	Stainless Steel	Temperature control from bottom only and for use with the Peltier plate cartridge (KNX2002 and KNX2002-E) and Active Hood Cartridge (KNX2007-E and KNX2007-X)	KNX0030
80 x 90	N/A	Stainless Steel	Temperature control from bottom only and only for use with the Peltier plate cartridge (KNX2002 and KNX2002-E)	KNX0041

See also page 23 for acrylic cups for the plate cartridges.

# Upper Cones

## Tips and Tricks

Cone and plate combinations consist of a flat lower plate with an upper geometry featuring a truncated cone. Measurements with these geometries are performed at a set gap (automatically controlled by the software). This is to allow for absolute viscosity measurements, where the whole sample is subjected to the same shear rate – a significant advantage over parallel plate geometries which have a range of shear rates across their radii and just the average is reported. There are a variety of materials and surface finishes to select from, e.g. roughened to prevent sample slippage.

### Cone angles

- The upper geometry angle can vary from typically  $0.5^\circ$  to  $4^\circ$ . The selection allows you to select your cone choice to achieve different shear rates. The smaller the cone angle, the higher the achievable shear rate. However, the presence of particles (and size) still needs to be considered.
- Cone and plates have a fixed (nominal) measuring gap; for a  $1^\circ$  cone, the gap is 30 microns; 70 microns for  $2^\circ$  cones and 150 microns for  $4^\circ$ . Particles ideally need to be at least 5 times smaller than these gaps to prevent jamming at the apex of the geometry. This can be a particular limitation for the use of cones with particulate dispersions considering the small truncation gap. Plate geometries are more suitable for highly filled samples as the measuring gap can be changed to accommodate for this. If no particles (or very small particles) are present, then no worries!



### Stainless Steel Upper Cones with Smooth Surface

Diameter (mm)	Cone Angle (°)	Material	Order Number
8	2	Stainless Steel	KNX0168
10	1	Stainless Steel	KNX0249
20	0.5	Stainless Steel	KNX0222
20	1	Stainless Steel	KNX2037
20	2	Stainless Steel	KNX2034
20	4	Stainless Steel	KNX2038
25	0.5	Stainless Steel	KNX2099
25	1	Stainless Steel	KNX2129
30	1	Stainless Steel	KNX2217
35	1	Stainless Steel	KNX2521
40	0.5	Stainless Steel	KNX2098
40	1	Stainless Steel	KNX2032
40	2	Stainless Steel	KNX2039
40	4	Stainless Steel	KNX2036
50	0.5	Stainless Steel	KNX0247
50	1	Stainless Steel	KNX2081
50	2	Stainless Steel	KNX2082
60	1	Stainless Steel	KNX2033
60	2	Stainless Steel	KNX2035



### Upper Cones with Roughened (Sandblasted) Surface

Diameter (mm)	Cone Angle (°)	Material	Order Number
20	4	Stainless Steel	KNX2038-SB
40	4	Stainless Steel	KNX2036-SB

### Titanium Upper Cones with Smooth Surface

Diameter (mm)	Cone Angle (°)	Material	Order Number
20	1	Titanium	KNX2125
35	1	Titanium	KNX0067
40	1	Titanium	KNX0064
40	2	Titanium	KNX0065
50	1	Titanium	KNX2176
50	2	Titanium	KNX2177
60	1	Titanium	KNX2126
60	4	Titanium	KN2342

### PEEK Upper Cones with Smooth Surface

Diameter (mm)	Cone Angle (°)	Material	Order Number
20	2	PEEK	KNX0161
40	1	PEEK	KNX2315
40	4	PEEK	KNX0187
50	2	PEEK	KNX0160
60	1	PEEK	KNX2316

### Acrylic and Hastelloy Upper Cones with Smooth Surface

Diameter (mm)	Cone Angle (°)	Material	Remarks	Order Number
40	1	Acrylic		KNX2313
60	1	Acrylic		KNX2314
40	1	Hastelloy	Cone and Plate Set	KNX2328

The High Temperature Cartridge geometries are precision made from stainless steel 316 and incorporate a hollow section in the extended shaft to prevent heat transfer along their length. This makes them thermally safe even for longer high temperature tests.

### Upper Cones with Smooth Surface for HTC Prime

Diameter (mm)	Cone Angle (°)	Material	Order Number
20	1	Stainless Steel	RHR000KIA51.205-00
20	2	Stainless Steel	RHR000KIA51.206-00
20	4	Stainless Steel	RHR000KIA51.207-00
25	1	Stainless Steel	RHR000KIA51.203-00
25	2	Stainless Steel	RHR000KIA51.204-00
40	1	Stainless Steel	RHR000KIA51.200-00
40	2	Stainless Steel	RHR000KIA51.201-00
40	4	Stainless Steel	RHR000KIA51.202-00

### Sample Handling and Trimming

Name	Material	Order Number
Sample spatula spoon and trim tool	Glass fiber reinforced polyamid	EQU0090
Asphalt or polymer melt trim tool	Stainless Steel	DSR0004



# Cups and Bobs



Cup and bobs, also known as concentric cylinders or coaxial cylinders, are used to typically measure the viscosity of free flowing liquids up to yielding fluids. Diameters typically range from 14 mm to 37 mm. Due to the in-built intelligent geometry recognition in the upper bob, not only are they recognized by Kinexus, they are also automatically configured ready for measurement. The majority of cups and bobs are designed to the DIN53019 standard.

## Tips and Tricks

Cup and bob geometries consist of a lower cup, to accommodate the sample, and an upper bob, to measure it. They are useful for lower viscosity samples because the extra surface area enhances sensitivity. The relatively large gap between the upper bob and wall of the lower cup is advantageous by preventing jamming of samples with larger particles. However, as true for any low viscosity materials measured with larger gaps, one needs to be cautious of the onset of Taylor (non-shear) flow influencing the results. This can be detected as a false increase in viscosity at higher shear rates. Cups can be selected with fill lines for ease of sample loading and with removable bottoms enabling easier cleaning between measurements. Similar to the other rheological measuring systems, there are options for different surface finishes and materials.

- **Surface finish** – for those challenging samples prone to slippage, measuring with a roughened or splined (~1 mm vertical grooves) cup and bob is recommended. If particles are present in the sample and sedimentation occurs, a spiralled bob may help slow or prevent the dispersion from settling during the measurement. If the dispersion is very unstable, then using a paddle will be more effective.
- **Vane tools** – are useful for measuring samples with very delicate structures such as foams or soft solids possessing a yield stress. The shape of the vane (as shown opposite) lends itself to slicing into the sample without disturbing or destroying too much of the structure prior to measurement (in comparison to a solid bob).
- **Double gap** – for extremely low viscosity samples, these geometries are a valuable option. The upper bob is hollow, providing an extra measuring surface area and consequently, increases sensitivity. The use of these geometries is recommended for more volatile samples due to the relatively large volume requirements. Another tip for measuring volatile samples is to use a passive solvent trap (KNX2513).



## Bobs

### Bobs with Smooth Surface

Name	Diameter (mm)	Material	Remarks	Order Number
C10	10	Stainless Steel	DIN Standard	RHR000KIA54.000-00
C14	14	Stainless Steel	DIN Standard Requires Gap Set Tool (KNX7058) when coupled with C25 or C34 cup	KNX2042
C25	25	Stainless Steel		KNX2043
C34	33.64	Stainless Steel	DIN Standard	KNX2079
C14	14	Titanium	To be coupled with a C37 cup	KNX2318
C25	25	Titanium		KNX0155

### Bobs with Roughened (Sandblasted) Surface

Name	Diameter (mm)	Material	Remarks	Order Number
C14	14	Stainless Steel	Requires Gap Set Tool (KNX7058) when coupled with C25 or C34 Cup	KNX2042-SB
C25	25	Stainless Steel		KNX2043-SB
C34	33.64	Stainless Steel	To be coupled with a C37 cup	KNX2079-SB



A 25mm diameter vane tool, roughened bob, splined bob and smooth bob

### Bobs with other Surface Finishes, e.g. splined, spiralled

Name	Diameter (mm)	Material	Remarks	Order Number
C14	14	Stainless Steel	Splined Surface Finish Requires Gap Set Tool (KNX7058) when coupled with C25 or C34 Cup	KNX2088
C25	25	Stainless Steel	Splined Surface Finish	KNX2087
C25	25	Stainless Steel	Spiralled Surface Finish	KNX2195



### Mooney Ewart Sets

Name	Diameter (mm)	Material	Remarks	Order Number
0.5 ml	25	Stainless Steel	0.5* – 1.0 ml cup and 25 mm bob, cone angle 2°	KNX2507
1.0 ml	25	Stainless Steel	1.0* – 1.5 ml cup and 25 mm bob, cone angle 2°	KNX2516
1.5 ml	25	Stainless Steel	1.5* – 2.0 ml cup and 25 mm bob, cone angle 2°	KNX2517

\* If the lower volume of each of these is used, the stress constant should be adjusted accordingly



## Double Gap Bob and Sets

### Double Gap Bob only with Smooth Surface

Name	Material	Order Number
25	Stainless Steel	KNX2132

### Double Gap Cup and Bob Sets with Smooth Surface Finish

Name	Diameter (mm)	Material	Remarks	Order Number
Double Gap Set	24/27	Titanium	Wide Gap	KNX0225
Double Gap Set	25	Stainless Steel		KNX2194
Double Gap Set	25	Anodized Aluminum Cup and Stainless Steel bob		KNX2046



# Vane Tools

Vane tools				
Name	Diameter (mm)	Material	Remarks	Order Number
V25	25 with 61 blade length	Stainless Steel	4 Blade Vane	KNX2045
V14	14 with 21 blade length	Stainless Steel	4 Blade Vane Requires Gap Set Tool (KNX7058) when coupled with C25 or C34 Cup	KNX2239
V14	14 with 61 blade length	Stainless Steel	4 Blade Vane Designed for use with a C25 Cup	KNX2044
V25 6	25 with 61 blade length	Stainless Steel	6 Blade Vane	KNX2097



# Cups

Cups with Smooth Surface				
Name	Diameter (mm)	Material	Remarks	Order Number
C10	10	Stainless Steel	DIN Standard Removable Base Design	RHR000KIA61.2000-00
C14	14	Stainless Steel	Removable Screw Base	KNX2512
C25	25	Stainless Steel	DIN Standard	KNX0027
C25	25	Stainless Steel	DIN Standard Removable Push-fit Base	KNX2178
C25	25	Stainless Steel	With Fill Line	KNX2337
C25	25	Stainless Steel	With Fill Line and Removable Push-fit Base	KNX2338
C25	25	Stainless Steel	Removable Screw Base	KNX2501
C34	37	Stainless Steel	Closed Base Design	KNX0029
C34	37	Stainless Steel	Removable Screw Base Recommended for KNX2238 starch upper geometry set	KNX2526
C14	14	Anodized Aluminum	DIN Standard Removable Push-ft Base	KNX2040
C25	25	Anodized Aluminum	DIN Standard Closed Base Design	KNX2041
C34	37	Anodized Aluminum	Closed Base Design	KNX0028
Double Gap Cup	25	Stainless Steel	Removable Base	KNX2201



Cups with Roughened Surface				
Name	Diameter (mm)	Material	Remarks	Order Number
C14	14	Stainless Steel	Closed Base Design	KNX2077-SB
C25	25	Stainless Steel	Closed Base Design	KNX0027-SB
C34	37	Stainless Steel	Closed Base Design	KNX0029-SB



### Cups with Splined Surface

Name	Diameter (mm)	Material	Remarks	Order Number
C14	14	Anodized Aluminum	Removable Push-Fit Base	KNX2085
C25	25	Anodized Aluminum	Removable Push-Fit Base	KNX2084



### Acrylic Cups for Plate Cartridge

Diameter (mm)	Material	Remarks	Order Number
37	Acrylic Walled, Lower Stainless Steel	Maximum Temperature is 80°C	KNX0134
50	Acrylic Walled, Lower Stainless Steel	Maximum Temperature is 80°C	KNX0127
80	Acrylic Walled, Lower Stainless Steel	Maximum Temperature is 80°C	KNX0135



37 mm Acrylic Cup



50 mm Acrylic Cup



80 mm Acrylic Cup

## Plate Inserts for Peltier Cylinder Environmental Controller

The plate inserts allow a Peltier Cylinder controller to be used with upper cones and plates between 5 – 90°C for isothermal tests.

### Plate Inserts

Diameter (mm)	Surface Finish	Material	Remarks	Order Number
61	Smooth	Stainless Steel	Solvent Trap Compatible, Recommended temperature range 5 to 90°C	KNX0112
61	Smooth	Aluminum	Solvent Trap Compatible, Recommended temperature range 5 to 90°C	KNX0110
61	Serrated	Stainless Steel	Solvent Trap Compatible, Recommended temperature range 5 to 90°C	KNX0111
61	Sandblasted	Stainless Steel	Solvent Trap Compatible, Recommended temperature range 5 to 90°C	KNX0112-SB

# Verification and Spare Parts

## Verification

Kinexus Rheometer Verification	
Item (Specified Viscosity at 25 °C)	Order Number
UKAS certified newtonian normal oil 1000 mPas (100 ml)	KNX0002
UKAS certified newtonian normal oil 10 Pas (100 ml)	KNX0003
High temperature standard canon oil (55 ml)	KNX0004
UKAS certified newtonian normal oil 0.1Pas (100 ml)	KNX0005
Standard viscosity oil 10mPas (50 ml)	KNX0006
UKAS certified newtonian normal oil 1 mPas (100 ml)	KNX0007
UKAS certified newtonian normal oil 20 mPas (100 ml)	KNX0048
UKAS certified newtonian normal oil 100.000 mPas (100 ml)	KNX0197
Standard viscosity oil 300 Pas (500 ml)	KNX0210
Standard viscosity oil 70 Pas (500 ml)	KNX0211
UKAS certified newtonian normal oil 5 Pas (500 ml)	NGB824047
Standard viscosity oil 1.6m Pas (100 ml)	ZZZ0772
DakkS certified newtonian normal oil 1000 mPas (100 ml)	NGB826140
Standard rheometer verification kit (consisting KNX0002, sample trim tool storage box)	KNX2009
Temperature calibration kit for automated temperature calibration (-40 °C to 100 °C / consisting of measuring device, DSR temperature sensor, thermal paste, a USB connection cable)	KNX4033

## Spare Parts

<b>Geometry Cleaning Set</b>	<b>Order Number: RHR000KIA96.101-00</b>
<b>Air Filter Units Mounting System</b>	<b>Order Number: RHR000KIA98.300-00</b>

### Air Supply

#### Regulator, Filter and Dryer

Item	Order Number
Standard Kinexus air filter regulator unit	KNX0233
Air regulator/absorption dryer unit	RHR000KIA98.000-00
Submicro oil particle filter unit	RHR000KIA98.100-00

#### Spare Parts & Replacement Dryer

Item	Order Number
Spare parts kit for standard Kinexus air filter regulator unit KNX0233 (consisting of reservoir o-ring, microfilter, submicrofilter)	RHR000KIA98.400-00
Spare parts kit for air regulator/absorption dryer unit RHR000KIA98.000-00 (consisting of reservoir o-ring, microfilter, submicrofilter)	RHR000KIA98.410-00
Replacement membrane dryer IDG60-F04, suitable for air regulator/absorption dryer unit RHR000KIA98.000-00	NGB826455
Replacement membrane dryer IDG50A-F02, suitable for air reg./filter dryer unit COM0040	NGB823924

### Heat Exchanger

Item	Order Number
Kinexus passive Heat Exchanger (Consisting of Heat Exchanger, expansion vessel, Coolant, Flow meter and connection hoses)	KNX2500
Kinexus Passive Heat Exchanger Coolant (Clear) Required for use with KNX2500	ZZZ0721
Hose Spare parts kit for Kinexus passive heat exchanger (Consisting of Flow meter, fittings, quick connect couplings and corresponding hose material)	RHR000KIA99.400-00
Replacement heat expansion vessel	KNX2278
Heat Exchanger replacement Inline Filter	FIL0146

### Miscellaneous Parts

Item	Order Number
USB cable shielded type A-B, 5 m long	NGB803534
USB 2.0 Cable A/B 3m, black, ferrite	NGB826077
USB 2.0 extension active A/A 5m	NGB826078

# Special Accessories

The modular design of Kinexus enables complete flexibility of accessory configuration with different cartridges and other options. The multi-functional accessory design provides a cost-effective solution allowing interchangeable upper and lower geometries, covering a wide application range.

The Kinexus incorporates a quick-connect engagement mechanism, intelligent auto geometry recognition and intuitive software guidance providing user feedback and easy to use interactive support.

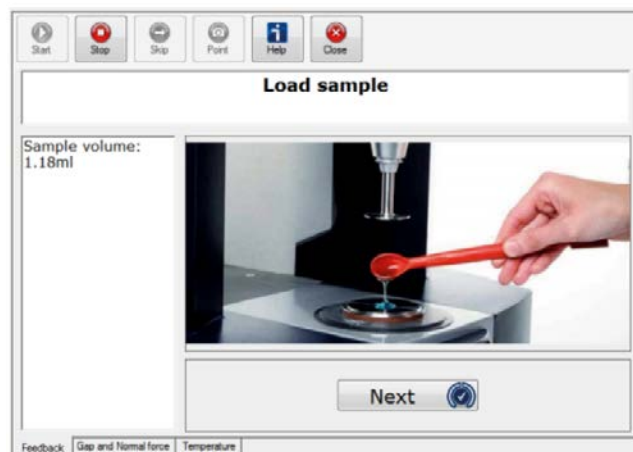

## Solvent Trap

The Kinexus solvent trap is an essential accessory when working with volatile samples prone to evaporation and drying. Providing thermal insulation from ambient conditions, the passive solvent trap KNX2513, also allows atmospheric gases to be purged across the sample via gas inlets. KNX2513 is compatible with both plate and cylinder cartridges. For measurements with an active hood cartridge the low profile KNX2514 should be used.



"Active" Solvent Trap (KNX2514)

Solvent Trap Systems		
Name	Remarks	Order Number
Passive Solvent Trap	<p>Cartridge Compatibility: KNX2001, KNX2001-E, RHR000KIA84.000-00, KNX2002-E and KNX2252</p> <p>Includes: Stainless Steel upper solvent reservoir, stainless steel thermal cover system, reservoir positioning tool and purge gas kit</p> <p>Upper geometry diameter range for use with passive solvent trap cover: 4 mm - 60 mm</p> <p>Requires a lower plate with solvent trap</p>	KNX2513
Active Solvent Trap	<p>Cartridge Compatibility: KNX2007-X and KNX2007-E</p> <p>Includes: Stainless Steel upper solvent reservoir and stainless steel covers</p> <p>Upper geometry diameter range for use with active solvent trap is 15 mm - 60 mm</p> <p>Requires a lower plate with solvent trap features (see pages 12 and 13)</p>	KNX2514

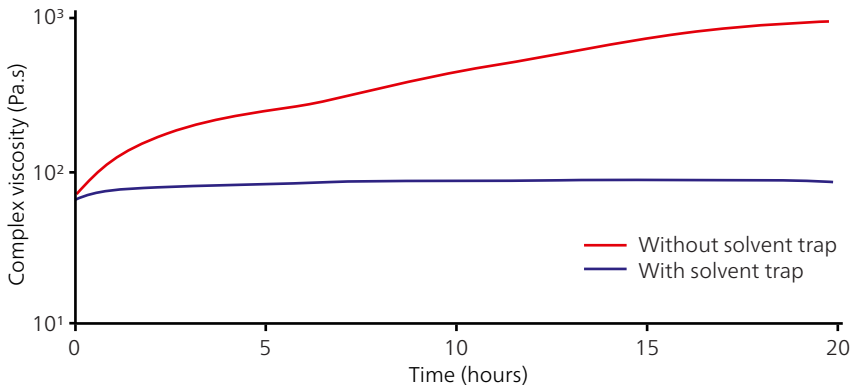

## Solvent Trap

- Prevents evaporation
- Controls the atmospheric gas
- Thermal insulation from ambient conditions

Application example: tomato ketchup. After the initial thixotropic rebuild of the sample, the solvent trap prevented drying by evaporation for up to 20 hours. A significant increase in viscosity can be observed for the measurement conducted without the solvent trap.



Solvent Trap (KNX2513)

## Universal Container Holder

The universal container holder enables sample testing within a petri-dish, custom container or beaker, particularly useful when analyzing delicate samples or where disturbance of structure should be avoided. This accessory allows the measurement of samples within their own containers, important for inherently thixotropic and/or set materials and gels (e.g. yoghurts). The testing is carried out under ambient conditions. The universal container is multi-functional, also serving as the base for the texture analysis accessory.

### Universal Container Holder

Version	Remarks	Order Number
Plate Version	Cartridge Compatibility: Peltier-Plate Cartridge (KNX2001 and KNX2001-E)	KNX0149
Cylinder Version	Cartridge Compatibility: Peltier-Cylinder Cartridge (KNX2002 and KNX2002-E)	KNX2277

## Universal Container Holder

- Sample containers can be loaded directly onto the instrument
- Eliminates unnecessary material handling
- Eliminates unwanted sample perturbation



Universal Container Holder for a plate cartridge (KNX0149)

# Texture Analysis

Texture analysis seeks to quantify various physical properties such as hardness and brittleness resilience by driving a measurement probe into a sample at a specific rate, with optional cyclic analysis.

## 3 Point Bend Kit

This texture analysis pack enables Kinexus to carry out classic 3 point bend tests on solid materials. The sample is bridged over two Aluminum lower triangular prisms mounted onto a Universal Container Holder (KNX0149 or KNX2277) to allow the distance between the prisms to be adjusted. The third prism / point is connected to the Universal Upper Geometry (KNX0095) to drive down onto the middle of this solid sample. Depending on the material a resistance-to-bend or required force-to-break can be measured at room temperature.

## Kinexus Texture Analysis Option with 3 Test Geometries (Aluminium)

This texture analysis package is a collection of 3 (1 hemisphere, 1 flat cone, 1 sharp cone) test geometries for connection to a universal upper geometry (M4). Typically, a semi-solid sample of approximately 5-10 cm thick/ deep is then placed on a standard plate cartridge and the force required to penetrate the sample is measured. Measurements are taken at room temperature using the various test geometries for different stiff materials. Requires KNX0095 Universal Upper Geometry (M4) to connect the probes to the rheometer.

Options for Texture Analysis			
Version	Material	Remarks	Order Number
Kinexus Texture Analysis Pack 3 Point Bend Kit	Aluminum	Cartridge Compatibility: KNX2001, KNX2001-E, KNX2002 and KNX2002-E Requires Universal Upper Geometry M4 (KNX0095) and either Universal Container Holder Plate Version (KNX0149) or Universal Container Holder Cylinder Version (KNX2277)	KNX2292
Kinexus Texture Analysis Option with 3 Test Geometries	Aluminum	Cartridge Compatibility: KNX2001, KNX2001-E, KNX2007-X, KNX2007-E Requires Universal Upper Geometry M4 (KNX0095)	KNX2293
Universal Upper Geometry (M4)	Stainless Steel		KNX0095



Kinexus Texture Analysis Option with 3 Test Geometries (KNX2293) with Universal Upper Geometry M4 (KNX0095)

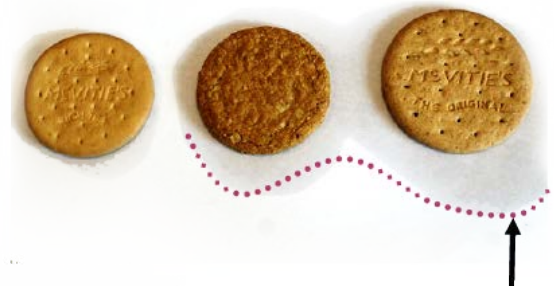
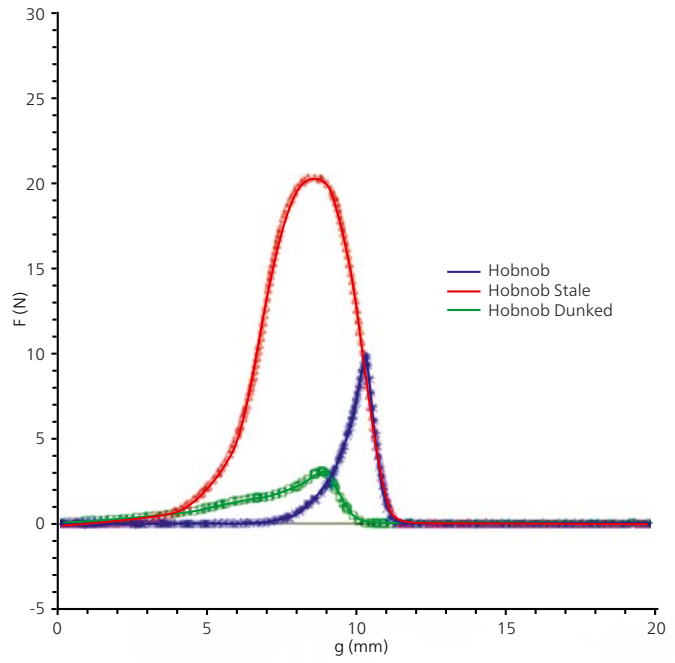
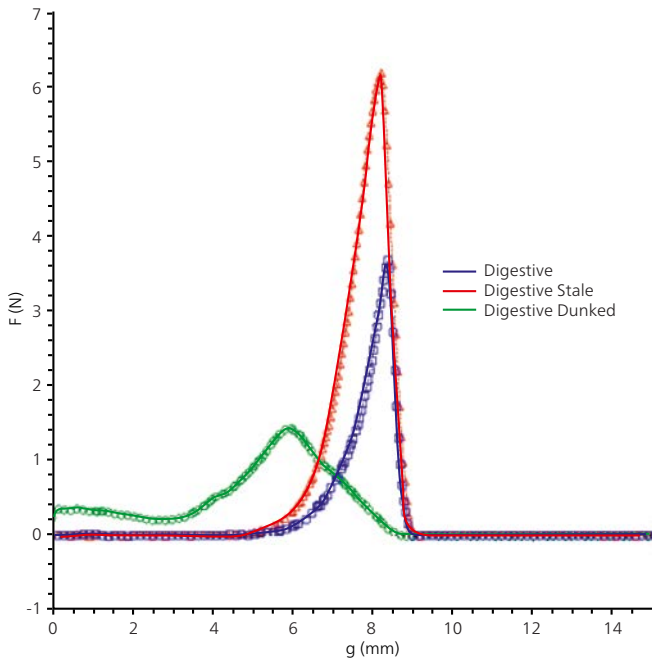

Loss of oil from biscuits over time as they become 'stale'



Kinexus ultra+ equipped with the universal container holder and the texture analysis 3 point bend kit (KNX2292)

## Texture Analysis

- Vertical three point bending and brittleness tests



# Disposable Plates

The disposable plate system is a perfect solution for studying samples that cure or set during testing such as thermosets, adhesives and paints. Both upper and lower disposable plates are available in various sizes and are easy to remove and dispose of following a measurement. Stainless steel (316 Grade) lower plate mount and clamp designed for optimized thermal properties and mechanical alignment. The disposable plates feature quick-connect engagement and release mechanism and the lower plate includes a solvent trap cover location ring.

Kinexus Peltier Disposable Plate System			
Set comprises	Quantity	Remarks	Order Number
Peltier Upper Geometry Adapter (KNX2148), Stainless Steel Disposable Lower Plates (KNX2204) and Lower Plate Clamp System (KNX2288)	100	Cartridge Compatibility: KNX2001, KNX2001-E, KNX2007-X and KNX2007-E	KNX2155

Kinexus HTC Prime Lower Disposable Plate System		
Quantity	Remarks	Order Number
25	Cartridge Compatibility: RHR000KIA84.000-00	RHR000KIA60.101-00

Disposable Upper Plates			
Diameter (mm)	Quantity	Material	Order Number
8	100	Aluminum	KNX2203
8	25	Stainless Steel	RHR000KIA50.130-00
10	100	Aluminum	KNX2325
10	25	Stainless Steel	RHR000KIA50.131-00
15	20	Aluminum	KNX2505
15	25	Stainless Steel	RHR000KIA50.132-00
20	25	Stainless Steel	RHR000KIA50.133-00
25	100	Aluminum	KNX2175
25	25	Stainless Steel	RHR000KIA50.134-00
40	100	Aluminum	KNX2233
40	25	Stainless Steel	RHR000KIA50.135-00

### Disposable Lower Plates

Diameter (mm)	Thickness (mm)	Quantity	Material	Order Number
63	0.1	100	Stainless Steel	KNX2204
63	0.5	25	Stainless Steel	RHR000KIA60.100-00

### Upper Geometry Adapter

Name	Order Number
Upper Geometry Adapter for Disposable Plates	KNX2148
Upper Geometry Adapter for HTC Disposable Plates	RHR000KIA57.000-00

### Disposable Plates Set (Upper and lower)

Diameter (mm)	Quantity	Material	Order Number
25	100 upper plates & 100 lower plates	Upper Plates: Aluminum Lower Plates: Stainless Steel	KNX2159
40	100 upper plates & 100 lower plates	Upper Plates: Aluminum Lower Plates: Stainless Steel	KNX2160

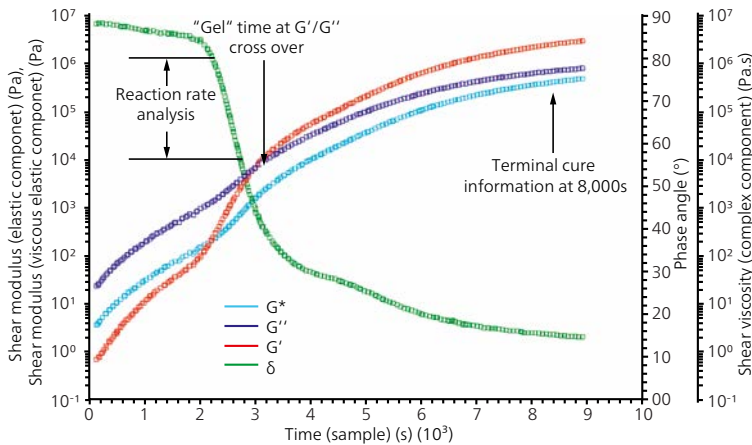

Disposable Plate System (KNX2155)



Disposable Lower Plates (KNX2204)

### Disposable Plates

- Rheology of thermosets
- Curing and adhesive testing
- Corrosive and abrasive samples
- Enables safe disposal of toxic and biohazard samples

# Tack Test Option

## Kinexus Measuring Option for Tack Tests with Clamping Device

- Benefit from the most sensitive normal force option and fastest vertical lift speed on the market.
- Designed for use with 2 mm lower disposable plates and up to 8mm upper plate diameters.
- The Kinexus special disposable plate system enables the use of lower disposable measuring plates with 2 mm thickness (not included), which can be easily removed and disposed of after measurement, e.g. for cross-linking samples or samples that are difficult to clean.
- The disposable plate system is designed as a retrofit kit for use with the Kinexus Peltier Plate Cartridge and the Kinexus Active Hood Cartridge. The temperature range depends on the respective cartridge.
- Consisting of an upper 8mm measuring plate, a lower measuring plate system incl. mounting ring with inner circular recess of 10 mm diameter.

Tack Test Option	
Set Name	Order Number
Kinexus measuring option for tack tests	RHR000KIA60.110-00



Tack test option (RHR000KIA60.110-00)

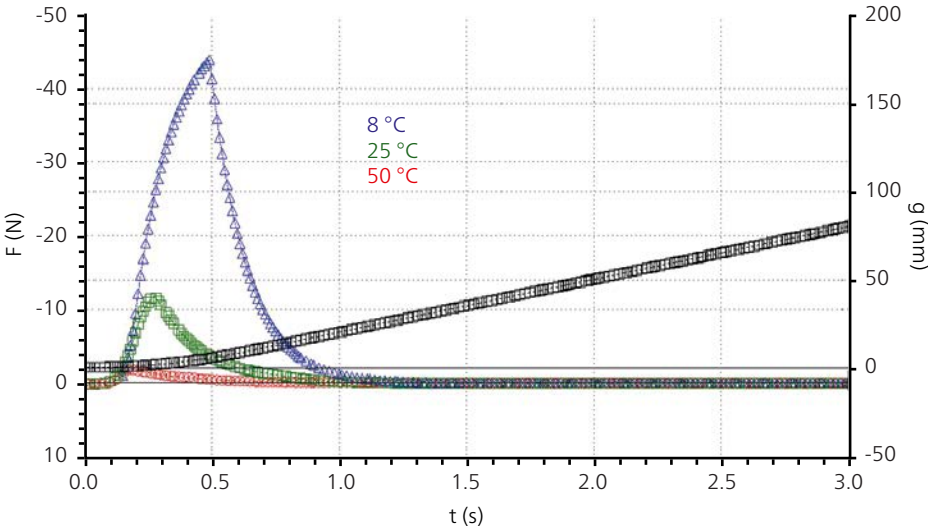

Temperature [°C]	Tack [N]	Cohesive strength [N/s]	Failure time [s]
8	43.1	16.2	0.82
25	11.8	3.3	0.74
50	1.8	0.6	0.69

Example measurement cosmetic wax at different temperatures

# DMA Accessories

The Kinexus Torsion/DMA system is designed to work with the concentric cylinder cartridge system allowing solid samples (e.g. final product) to be tested directly. The system extends the current characterization capabilities of the Kinexus, allowing mechanical properties and material transitions to be evaluated as a function of time, temperature, stress and strain, in both dry and wet environments. This system is suitable for a self-supporting rectangular or cylindrical solid sample. Applications include measurement of composites, polymer strips or even asphalt cores through to composites in a dry or wet temperature controlled environment. Sample Dimensions are up to: Rectangular 50 mm (Height) x 15 mm (Width) x 15 mm (Depth), and Cylindrical 50mm (Height) x 25 mm (Diameter) using appropriate disposable plate or end cap. The actual achievable sample temperature depends on the respective application.

## Torsion/DMA System incl. Alignment Jig

Set comprises	Remarks	Order Number
Torsional fixtures, alignment jig (KNX2249), 10 disposable cylindrical sample end caps for use with max. sample diameter of 13mm (KNX4024), Thermal cover, digital caliper, torque screwdriver and a set of clamp spacer.	Cartridge Compatibility: KNX2002 and KNX2002-E	KNX0158

## Recommended for use with the Torsion/DMA System

Name	Quantity	Order Number
13mm End Cap Cylindrical Torsion	100	KNX4024



## Torsional DMA

- Dry and wet environments
- Benefit from most sensitive normal force option to characterize thermal expansion and shrinkage
- Alignment jig for user-friendly specimen preparation
- Measure torsional stiffness
- Measure moisture/solvent absorption with time
- Control temperature and oscillation parameters

The Kinexus Three Point Bend accessory uses the temperature control inside the Kinexus plate and active hood environmental controllers to extend the measurement range of a rotational rheometer to solids. A solid strip of material is probed, typically with a small vertical static deformation.

Kinexus Three Point Bend Accessory		
Set comprises	Remarks	Order Number
Upper and lower geometry. The lower geometry is used to hold the solid specimen.	Cartridge Compatibility: KNX2001, KNX2001-E, KNX2007-E, KNX2007-X	KNX2236

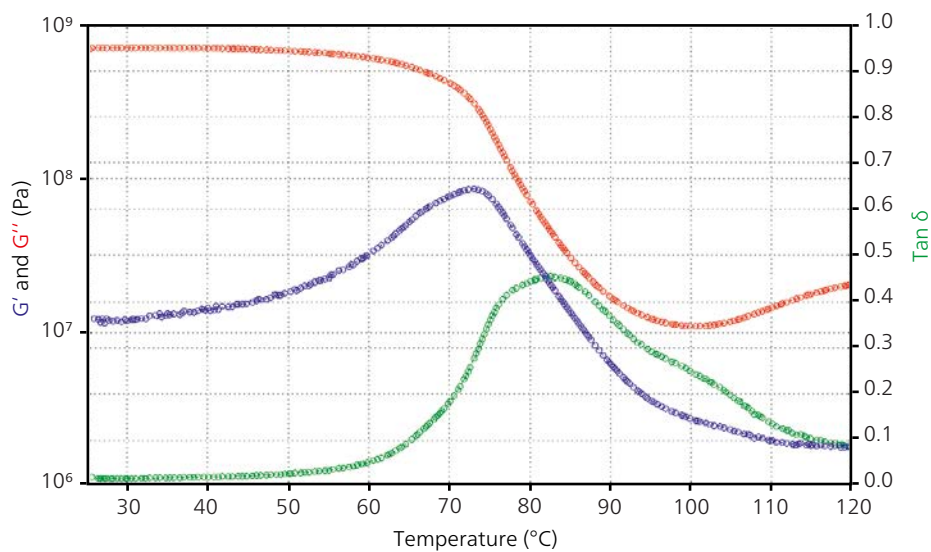

Temperature sweep of a polymer blend (PLA/PCL) using the Torsion/DMA system.

# Tribology

Tribology is the study of friction and lubrication between interacting surfaces in motion. This tribology accessory is designed to investigate the lubricating properties of a sample by measuring the friction (torque) under a constant applied normal force. It can also be used to determine the wear of different materials. Stainless steel (316 grade) upper and lower geometry design. Removable and replaceable wearing components. Alternative materials (such as Aluminum, PP, HDPE and hydroxyapatite (bone)) may be available on request.

Accessories for Tribology		
Name	Remarks	Order Number
Tribology cell	Cartridge Compatibility: KNX2001, KNX2001-E, KNX2007-X and KNX2007-E (with hood open)	KNX2281
Three balls on plate tribology cell	Cartridge Compatibility: KNX2001, KNX2001-E, KNX2007-X and KNX2007-E (with hood open)	KNX2282
Hood for tribology cell KNX2281	For when KNX2281 is used together with plate cartridge KNX2001. Includes an integrated solvent trap	RHR000KIA83.300-00



Tribology cell (KNX2281)

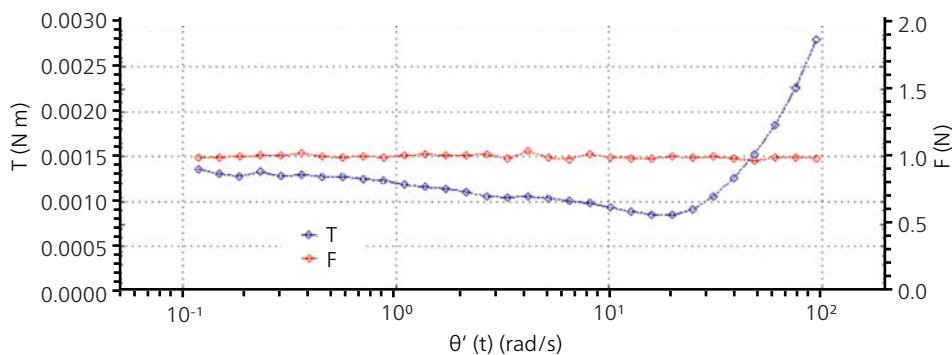

Typical results plot torque (i.e. resistance) against angular velocity under constant force Friction is measured under different speeds

### Specimen for Tribological Testing

Name	Material	Quantity	Remarks	Order Number
Spare Stainless Steel Ball	Stainless Steel	1	For KNX2281 and KNX2282	KNX2291
Spare Plate Inserts	Stainless Steel	30	For KNX2281	KNX2304
Spare Plate Inserts	Stainless Steel	100	For KNX2281	KNX2290
Spare Plate Inserts	Stainless Steel	500	For KNX2281	KNX2302
Spare Plate Inserts	Stainless Steel	1,000	For KNX2281	KNX2303
Spare Plate Inserts	Aluminum	50	For KNX2281	KNX2298
Spare Plate Inserts	Aluminum	100	For KNX2281	KNX2299
Borosilicate Glass Balls	Borosilicate	100	For KNX2281 and KNX2282	RHR000KIA96.040-00
Spare Plate Inserts	SYLGARD 184	1	For KNX2281	NGB825372
Spare Plate Inserts	SIL30	1	For KNX2281	NGB825217

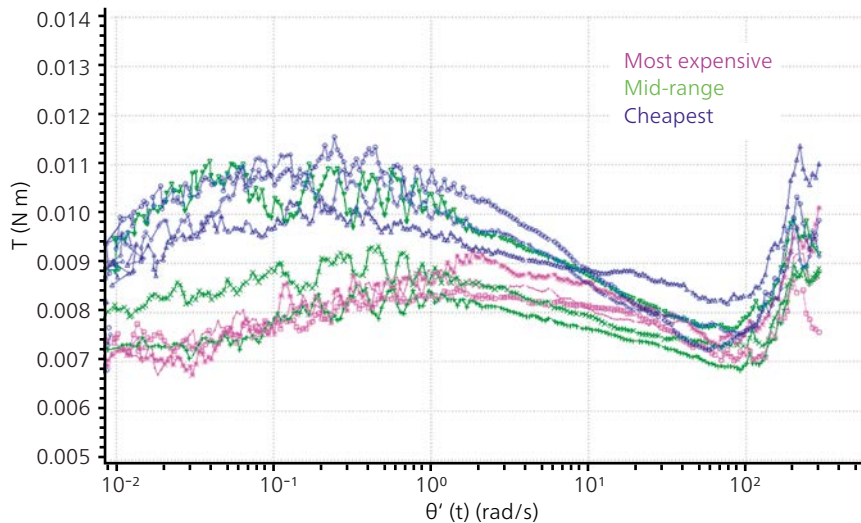

A comparison of three different priced engine oils, with three repeats of each type. The cheapest oil exhibits a higher torque (and therefore friction) than the most expensive oil.



# UV Curing System

UV-curable materials are widely used in coatings, adhesives, and dental compounds. When these materials are exposed to UV radiation, a fast cross-linking reaction occurs, typically within less than a second to a few minutes. Rheometers are used to monitor the curing process and measure the modulus change of the material.

The Kinexus Optical Cell utilizes the open base designs of the Kinexus platform and cylinder cartridge (KNX2002) enabling the required optical train to be used when shear is applied to the material.

The Kinexus UV curing system enables the rheological properties of a UV-curing material to be monitored over time during the application of UV light. The rSpace software includes an intuitive interactive guide automatically employed for when operating the UV curing accessory. UV light intensity can be controlled and programmed within the software.

## Kinexus Optical Cell Mechanics

Comprises	Remarks	Order Number
Optical plate insert with two removable Quartz Glass plates (KNX5009) with >90% transmission over 270-2000 nm, solvent trap cover location ring and lower reservoir, customizable/removable insert sleeve to fit custom components.	Cartridge Compatibility: KNX2002 and KNX2002-E Upper geometry diameter range is 4mm - 50mm. Recommended temperature range for use is from 5 to 170°	KNX5008

## Recommended parts for customized optical trains for KNX5008

Name	Order Number
Kinexus System Stand	KNX5010
Kinexus Frame Universal Mount	KNX0132
Kinexus Frame Universal Fixture	KNX0133

## Kinexus UV Cell Mechanics (DOES NOT include Light Source)

Comprises	Remarks	Order Number
UV plate insert with five (5) removable UV Transparent Borosilicate Glass plates (KNX5013) with >90% UV transmission over 350-500 nm and UV light blocking solvent trap system (solvent trap cover location ring and lower reservoir)	Cartridge Compatibility: KNX2002 and KNX2002-E Recommended light source is Omnicure® S2000 XLA Spot Cure Unit light source with 320-500nm filter fitted and UV 8mm x 1m Liquid Light Guide Upper geometry diameter range is 4mm - 50mm for non-UV measurements and 4mm - 40mm for UV measurements. Recommended temperature range when UV light guide attached is from 5 to 80°C and without UV light guide attached is from 5 to 170°C.	KNX5000

The intensity signal from the Omnicure® S2000 is captured in real-time during the UV measurement.

### Kinexus UV Cell Mechanics with S2000 Light Source

Comprises	Remarks	Order Number
<p>UV plate insert with five (5) removable UV Transparent Borosilicate Glass plates (KNX5013) with &gt;90% UV transmission over 350-500 nm and UV light blocking solvent trap system (solvent trap cover location ring and lower reservoir)</p> <p>Omnicure® S2000 XLA Spot Cure Unit light source with 320-500nm filter fitted, UV 8mm x 1m Liquid Light Guide and Kinexus Light Guide holder.</p>	<p>Cartridge Compatibility: KNX2002 and KNX2002-E</p> <p>Upper geometry diameter range is 4mm - 50mm for non-UV measurements and 4mm - 40mm for UV measurements.</p> <p>Recommended temperature range when UV light guide attached is from 5 to 80°C and without UV light guide attached is from 5 to 170°C.</p>	KNX5007



Kinexus Prime ultra+ equipped with the UV Curing System (KNX5007)



Kinexus UV Cell Mechanics only (KNX5000)

### Kinexus UV Cell Mechanics with LX500

Comprises	Remarks	Order Number
<p>UV plate insert with five (5) removable UV Transparent Borosilicate Glass plates (KNX5013) with &gt;90% UV transmission over 350-500 nm and UV light blocking solvent trap system (solvent trap cover location ring and lower reservoir) Includes an Omnicure® LX500 light source - Kinexus LED Light Guide holder. LED Head with specific wave length to be purchased separately. Select at least one of KNX0261, KNX0262, KNX0263, KNX0264 or KNX0265</p>	<p>Cartridge Compatibility: KNX2002 and KNX2002-E</p> <p>Upper geometry diameter range is 4mm - 50mm for non-UV measurements and 4mm - 40mm for UV measurements. Recommended temperature range when UV light guide attached is from 5 to 80°C and without UV light guide attached is from 5 to 170°C.</p>	KNX5020

### Optional parts for KNX5007, KNX5000 and KNX5020

Comprises	Order Number
Kinexus System Stand	KNX5010
Disposable Upper Plates (Diameter: 25mm; Quantity = 100)	KNX2175
Disposable Upper Plates (Diameter: 40mm; Quantity = 100)	KNX2233
Upper Geometry Adapter for Disposable Plate System	KNX2148

### Other UV Cell Accessories

Comprises	Remarks	Order Number
Kinexus UV Radiometer for S2000 Radiometer R2000	Allows accurate calibration of the light intensity at the sample	NGB810436
Kinexus UV Light Guide for S2000		NGB813840
Kinexus UV Transparent Borosilicate Glass Plate	>90% UV transmission over 350-500 nm	KNX5013
Quartz Glass plates for Optical Cell	>90% transmission over 270-2000 nm	KNX5009

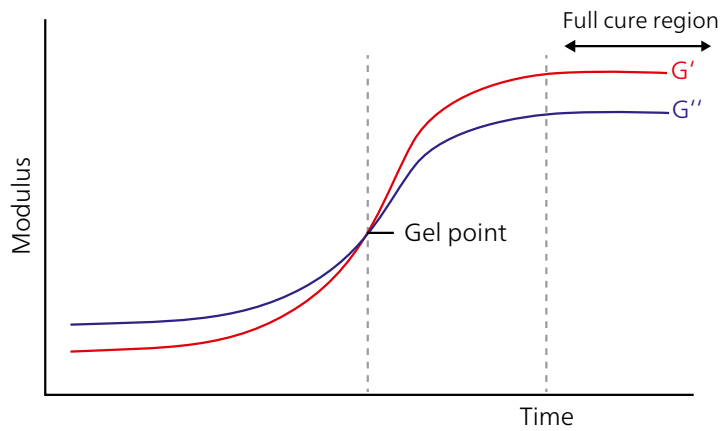
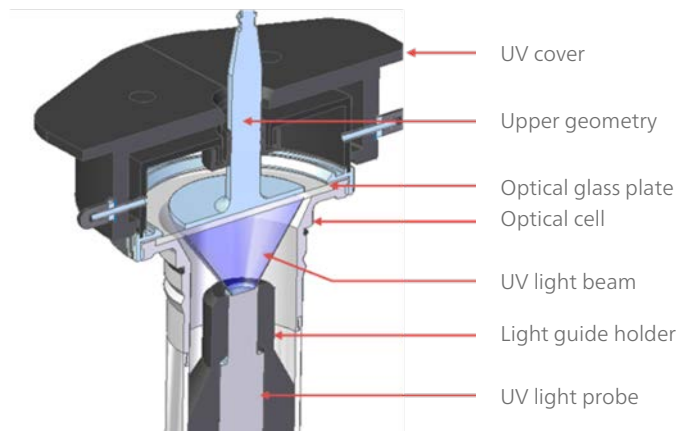

## UV-Curing System

- Track the cure properties of samples with varying UV intensity, film thickness, time and temperature
- Safe and enclosed automated exposure cell
- Software controlled light source

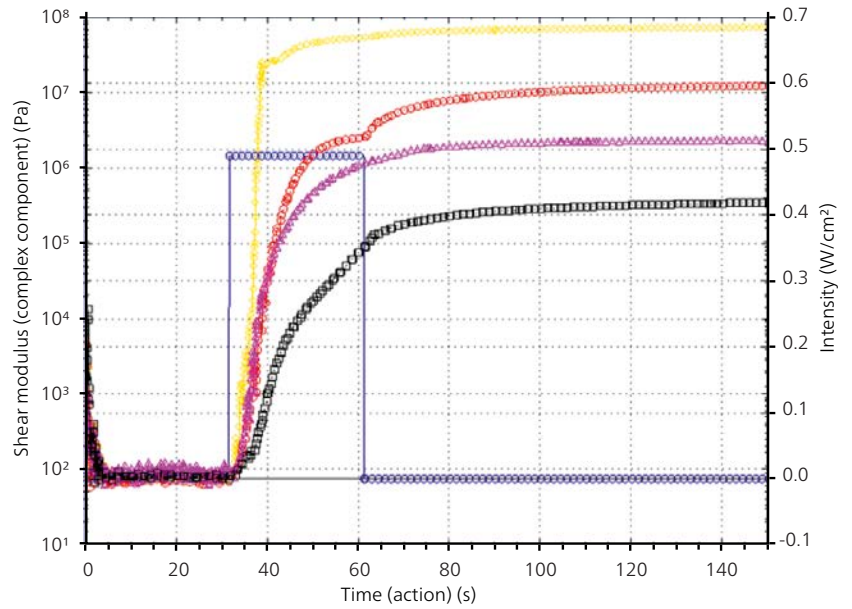

Comparison of different color gels. Curing is initiated when the UV light is applied (blue) and complex modulus data is monitored over time.

## Twin Orbital Ball

The twin orbital ball geometry is designed for measuring large particulate samples such as cements and slurries.

### Twin Orbital Ball

- Measure start up stress
- Measure flow properties of large aggregate mixes

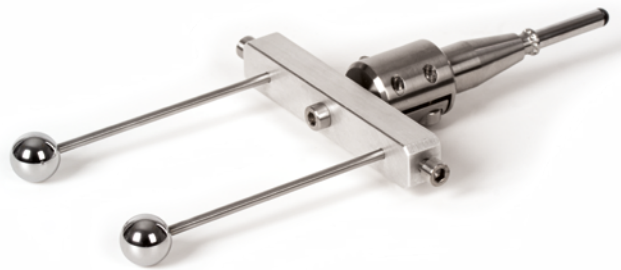

Twin Orbital Ball

### Twin Orbital Ball

Material	Remarks	Order Number
Stainless Steel	Cartridge Compatibility: KNX2001, KNX2001-E Recommended to use with Cup 80mm Diameter for Plate Cartridge (KNX0135); Can also be used with own cups and the Universal Container Holders	KNX2525

# Crumb Rubber Kit

The crumb rubber kit consists of a shallow hard-anodized Aluminum cup for use with the Kinexus cylinder cartridge and is designed to measure crumb rubber asphalt mixtures. It is a low volume, wide gap concentric cylinder enabling samples with larger particles to be measured for more accurate testing.

The crumb rubber cup is typically used with KNX2042, a C14 Bob (14 mm diameter), providing a 6.75 mm working gap. The tapered, funnel opening, makes sample loading and cleaning easier while the shallow, low volume cup, permits a faster and more stable time to thermal equilibrium with minimal thermal gradients. The removable Snap-On base enables easy cleaning.

Optionally, the crumb rubber cup can be used with up to a 25 mm bob or short vane fixtures.



Crumb Rubber Kit (KNX2230)

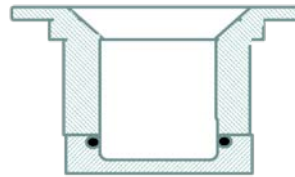

Simple Cross Section View

Crumb Rubber Kit		
Name	Remarks	Order Number
Crumb Rubber Kit	Cartridge Compatibility: KNX2002 and KNX2002-E Recommended to be used with upper fixture KNX2042 and/or KNX2239 and/or KNX2088	KNX2230

## Crumb Rubber Kit

- Designed for measuring the rheology of rubber modified asphalt blends
- Excellent thermal insulation
- Temperatures up to 200°C

# Rheo-Microscope

The Rheo-Microscope allows users to research the rheology of a sample while simultaneously viewing the microstructural changes occurring. It can be used to see particle agglomeration and dispersion under varying shear conditions, or to see an emulsion ripen with time at elevated temperature (providing the contrast between the particles and matrix are significant and size exceeds  $\sim 5\mu\text{m}$ ).

The microscope is mounted underneath a quartz plate (directly below the sample) allowing processes such as the break-up of emulsion droplets, alignment of particulates or fibres in a flow field and/or imaging of shear flow or shear banding within a sample.

The UV/Visible Transparent Borosilicate Glass plate used with the UV Curing System can also be configured with a microscope to allow microstructural changes to be observed during rheological testing.

Rheo-Microscope Kit		
Name	Remarks	Order Number
Rheo-Microscope	Cartridge Compatibility: KNX2002 and KNX2002-E Includes: USB microscope with fixation device Kinexus Optical Cell Mechanics (KNX5008) Feet extensions (to raise the height of the Kinexus for easy access to optics)	KNX0239

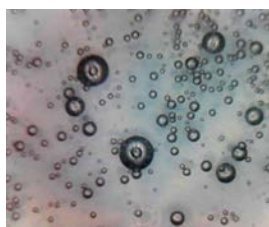

$0\text{ s}^{-1}$

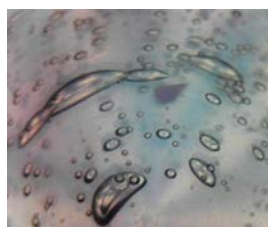

$100\text{ s}^{-1}$



$1000\text{ s}^{-1}$



ELONGATION & DEFORMATION OF BUBBLES

## Key Features

- Adjustable radial position – to enable imaging at various shear positions
- From centre position to outer edge of plate
- Adjustable axial position for focal plane control
- Monitor shear banding (sample dependent)
- Temperature control from the cylinder cartridge
- Allows for the sample temperature to remain consistent during measurement
- Quick release mechanism to allow optics to be removed for post-imaging high temperature measurements where the electronics would limited the maximum testing/imaging temperature

By taking advantage of the modular design of Kinexus, a microscopy accessory can be attached to the Kinexus optical plate providing imaging of samples under shear.

With a magnification of up to 200x, recording at up to 30 fps and a maximum resolution of 1600 x 1200 pixels, details of material structure can be seen under shear and rest conditions (sample dependent).

For example, investigations into the onset of shear thinning and correlation to deformations in the bulk material structure can be made.

## Rheo-Microscope

- View, photograph & video your sample while measuring the rheology
- Observe structural changes of emulsions & dispersions under varying shear & temperature conditions



Cylinder Cartridge (KNX2002) with  
Optical Cell Mechanics (KNX5008)

# Rheology of Dispersions – Starch Pasting Cell

Starch is commonly used in food processing – when it is dissolved in water it can be used as a thickener or stiffening agent.

The Kinexus rheometer can monitor the changes in viscosity of the sample as the starch dissolves, however the challenge is to keep the starch granules suspended and mixed. The Kinexus starch paddle and analysis in rSpace provides starch paste variables such as peak viscosity, holding viscosity and final viscosity.

Starch Pasting Cell – Upper Geometry Set		
Material	Remarks	Order Number
Stainless Steel shaft	Removable & reusable propeller (5 paddles) Cartridge Compatibility: KNX2002 and KNX2002-E	KNX2238

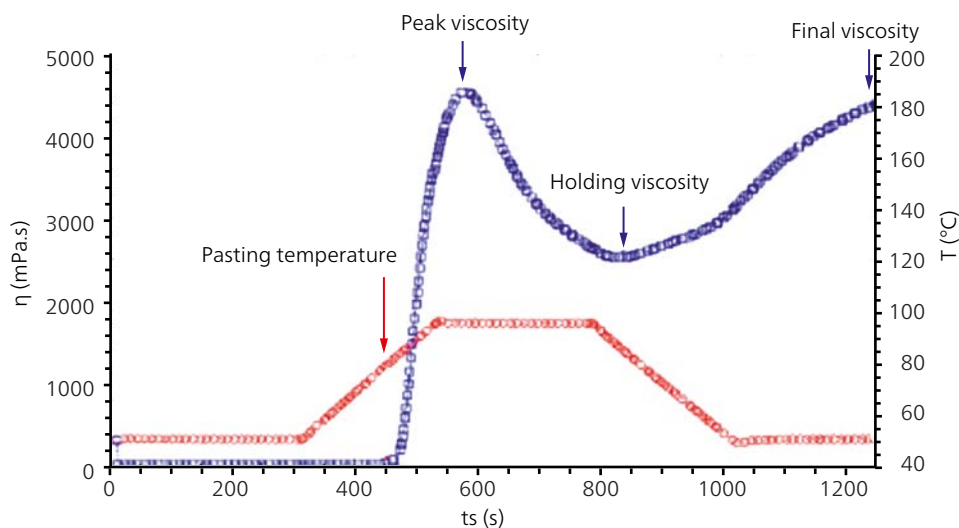

Starch System (KNX2238) with C34 Cup (KNX2526)

- Pasting Temperature
- Temperature at which the starch starts to dissolve
- Peak Viscosity
- Highest Viscosity where all of the starch has dissolved, before breaking down under shear
- Holding Viscosity
- The viscosity after the constant shear, breaking down the associated structure
- Final Viscosity
- Viscosity of the paste after cooling

## Starch Pasting Cell

- Analysis of starch pasting and gelatinization behavior in a controlled environment (ICC 162 standard)
- Dispersion and testing of starch and rice flour powders according to AACC international, ICC, RACI and PRC standard methods.
- Full temperature, shear rate, stress, speed and gap control



# Rheology of Dispersions – Twin Dispersion Paddle

The twin dispersion paddle is designed to be used for materials prone to sedimentation or multi-part systems requiring mixing. The upper shaft is insulated with PEEK in order to prevent heat flux during mixing at higher temperatures. In order to optimise mixing, the 22.5 paddle should be used in conjunction with a C25 DIN cup. Roughened and splined versions of these cups are also available to aid in the prevention of slippage.

Twin Dispersion Paddle		
Material	Remarks	Order Number
Stainless Steel and PEEK	22.5 mm to be used with a C25 cup Cartridge Compatibility: KNX2002 and KNX2002-E	RHR000KIA55.000-00
Stainless Steel and PEEK	32 mm to be used with a C34 cup Cartridge Compatibility: KNX2002 and KNX2002-E	RHR000KIA55.010-00

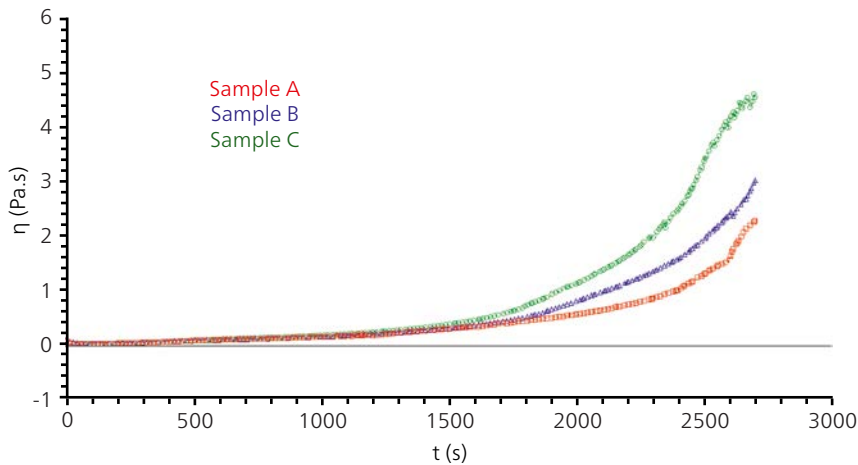

PMMA powder dissolving in MMA liquid to observe the dissolution time. The effect of MW and MWD of the polymer, temperature and shear rate on the dissolution time can be determined. We can see that sample C dissolved at a faster rate, whilst sample A was slowest.

# Du-Nouy Ring

The Du-Nouy ring can be used for measuring the surface tension, surface rheology and interfacial rheology of materials with strong interfaces, i.e. the interface between two immiscible fluids such as oil and water. A standard Du-Nouy ring is used in combination with the low inertia design and low torque sensitivity of the Kinexus motor to allow for the most sensitive measurements on a rotational rheometer.

Du-Nouy Ring		
Material	Remarks	Order Number
Platinum iridium	Requires Custom Geometry Adapter (KNX2174) Cartridge Compatibility: KNX2001, KNX2001-E if using Cups for Plate Cartridge with diameters 37mm (KNX0134), 50mm (KNX0127) or 80mm (KNX0135) KNX2007-X and KNX2007-E if using Cups for Plate Cartridge with diameters 37mm (KNX0134) or 50mm (KNX0127)	KNX4041



Du Nouy Ring (KNX4041) with Custom Geometry Adapter (KNX2174)



50 mm diameter cup (KNX0127)



37 mm diameter cup (KNX0134)

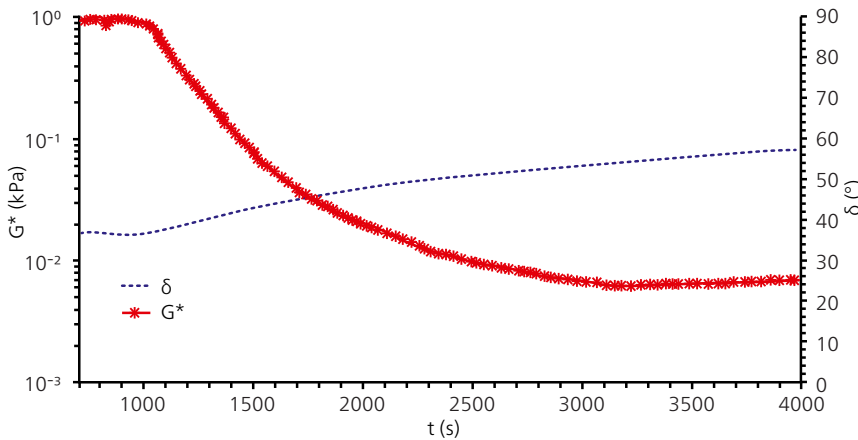

The example data shows the evolution of an interface of crude oil and water in the presence of an additive/surfactant.

## Du-Nouy Ring

- Measure surface tension and the surface rheology of a liquid
- Determine surface changes with varying shear, temperature and time

# Interfacial Rheology – Bi-Cone

The bi-cone is used for testing the interfacial rheology of materials. It incorporates both a cone on the underneath and top of the measuring interface, and is designed to measure the rheological properties at the interface between two immiscible fluids.

Bi-Cone		
Material	Remarks	Order Number
Stainless Steel	42.5 mm diameter with a 5° cone Cartridge Compatibility: KNX2001 and KNX2001-E if using Cup for Plate Cartridge with diameters 50mm (KNX0127) or 80mm (KNX0135) KNX2007-X and KNX2007-E if if using Cup for Plate Cartridge with diameters 50mm	KNX0126



Bi-Cone (KNX0126)



## Bi-Cone

- Measures interfacial rheology phenomena between immiscible liquids or liquid/air interfaces
- Determine interfacial rheology changes with varying shear, temperature and time

# Immersion Cell

The immersion cell allows samples to be tested with a cone or plate while fully immersed in a buffer or solvent. Samples (such as hydrogels or biological tissues) can be immersed in a liquid, allowing measurements to be conducted to simulate in-vivo or fully immersed conditions.

Immersion Cell		
Material	Remarks	Order Number
Stainless Steel	Cartridge Compatibility: KNX2001, KNX2001-E, KNX2007-X and KNX2007-E (only with open hood)	RHR000KIA62.110-00



Immersion Cell (RHR000KIA62.110-00)

## Immersion Cell

- Allows samples, e.g., hydrogels and tissue samples, to be tested while immersed in water or buffer
- Prevents drying
- Controls temperature, ionic strength and can simulate in-vivo situations

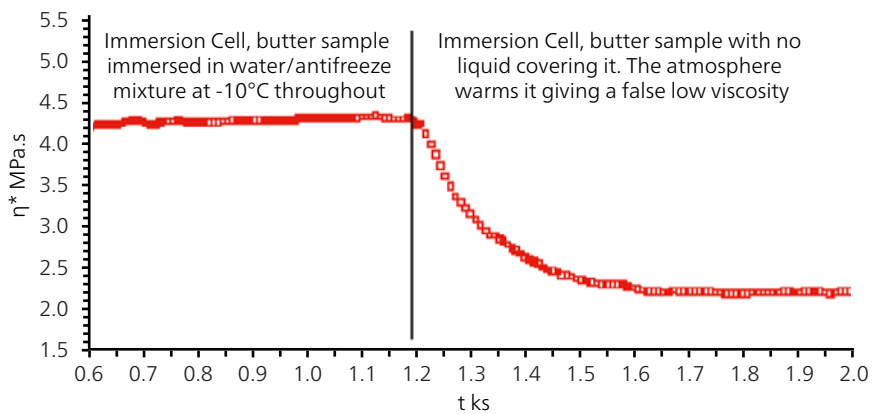

The effects of immersing a sample under a liquid for enhanced temperature control. The change of complex modulus is monitored with time. Similarly a sample could be initially tested dry and then under a solvent to determine dissolution time, etc.

# Immobilization Cell

The Kinexus immobilization and dehydration cell enables standard rheological testing to be performed whilst the sample is dried. These measurements are valuable for the evaluation of paints and paper coatings, for example. A vacuum is applied beneath a sintered/porous lower plate drawing liquid away through a substrate paper from the sample over time, while simultaneously shearing the sample. While dewatering tests are easy to conduct in a stationary filter funnel, paper coatings require shear during this test, as platy clays and other high aspect ratio materials align differently when sheared, hindering saturation of the base layer.

Immobilization Cell		
Name	Remarks	Order Number
Immobilization Cell	Cartridge Compatibility: KNX2002 and KNX2002-E	KNX0140

Immobilization measurements are made to determine the effects of:

- Solids content
- Porosity of the coating substrate
- thickness of the coating substrate
- Water retention additives
- Applied pressure drop



Immobilization Cell (KNX0140)

## Features/Specifications

- Can be used with plates and cones up to 45 mm diameter
- Applied pressure drop – Up to 100,000 Pa (1 bar) depending on pump used
- Range of porous and sintered substrates
- Measures all rheological properties
- Can be used with a standard solvent trap system

## Immobilization Cell

- Measures dewatering time of a sample during shear
- Determine effects of particle shape
- Measure effectiveness of surface sizing
- Simulate coating processes

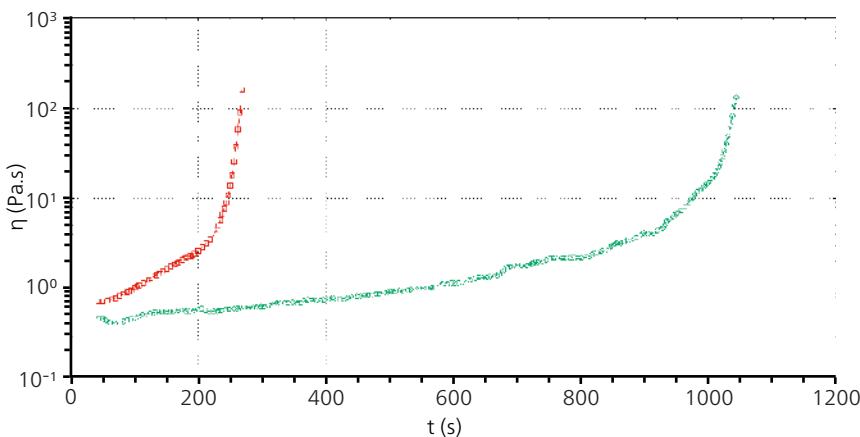

Viscometry measurements using the immobilization cell on coating slurries. Unsized paper samples (red) and sized paper samples (green). The sized paper has a significantly longer water retention time than unsized paper.

# Mooney Ewart

The Mooney Ewart features a conical bottom on the upper bob geometry. Incorporating a cone on the upper geometry enables the shear rate at the bottom of the bob to match that on the sides, between the bob the cylinder to enable absolute viscosity measurements. The measuring system for Kinexus has a focus on small sample volumes and high shear rates.

Mooney Ewart					
Diameter (mm)	Cone Angle (°)	Surface Finish	Material	Remarks	Order Number
1.0 ml Cup, 25 mm bob	2	Smooth	Stainless Steel	Cartridge Compatibility: KNX2002 and KNX2002-E	KNX2507
1.5 ml Cup, 25 mm bob	2	Smooth	Stainless Steel	Cartridge Compatibility: KNX2002 and KNX2002-E	KNX2516
2.0 ml Cup, 25 mm bob	2	Smooth	Stainless Steel	Cartridge Compatibility: KNX2002 and KNX2002-E	KNX2517

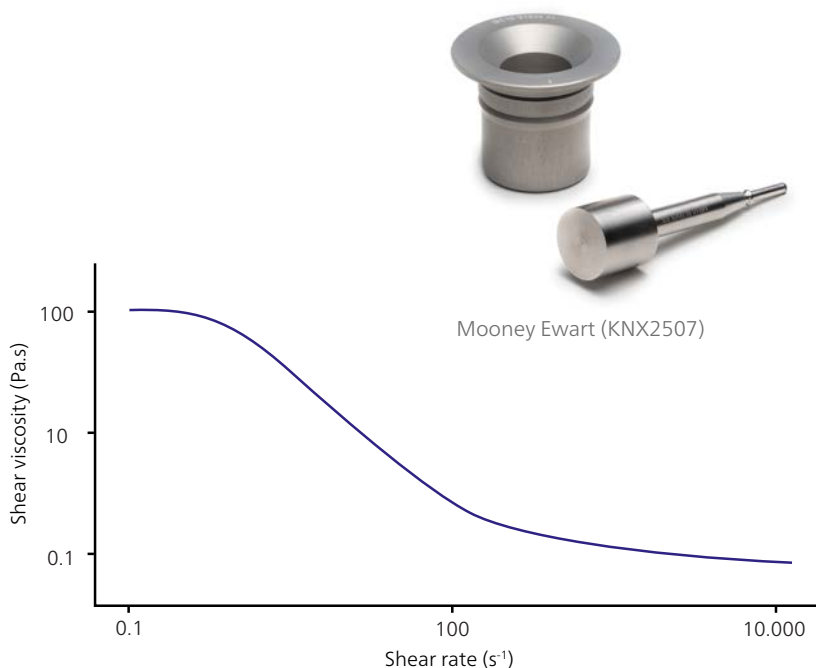

## Mooney Ewart

- The Mooney Ewart adaption is used to measure yield stress and viscosity flow properties. It applies a uniform shear history to the sample and controls shear stress and shear rate temperature.

The Mooney Ewart configuration is a special cup and bob, or coaxial cylinder, measuring system for Kinexus which has a focus on small sample volumes and high shear rates.

The advantages of this cell is that it is considered an “absolute” geometry as a uniform shear rate is applied to the sample (unlike that applied by a conventional DIN53019 cup and bob system). The uniform shear rate is achieved by matching the shear rate from the cup and bob vertical walls, with that of a cone and plate system at the end of the bob. In comparison to standard cup and bobs, the measuring gap for a Mooney Ewart system is relatively small, therefore higher shear rates can be achieved. In addition, the smaller measuring gap requires a lower sample volume, particularly important for valuable materials or those produced in limited quantities.

# Expertise in Service

CLOSE TO OUR WORLDWIDE CUSTOMERS



## Our Expertise – Service

All over the world, the name NETZSCH stands for comprehensive support and reliable service, before and after sale. Our qualified personnel from the technical service and application departments are always available for consultation.

In special training programs tailored for you and your employees, you will learn to tap the full potential of your instrument.

To maintain and protect your investment, you will be accompanied by our experienced service team over the entire life span of your instrument.

## Our Expertise – Application Laboratories

The NETZSCH Thermal Analysis applications laboratories are a proficient partner for nearly any thermal analysis and rheological issue. Our involvement in your projects begins with proper sample preparation and continues through meticulous examination and interpretation of the measurement results. Our diverse methods and over 30 different state-of-the-art measuring stations will provide ready-made solutions for all your thermal needs.

Within the realm of thermal and rheological analyses and the measurement of thermophysical properties, we offer you a comprehensive line of the most diverse analysis techniques for materials characterization.

Measurements can be carried out on samples of the most varied of geometries and configurations. You will receive high-precision measurement results and valuable interpretations from us in the shortest possible time. This will enable you to precisely characterize new materials and components before actual deployment, minimize risks of failure, and gain decisive advantages over your competitors.

### TECHNICAL SERVICE



Maintenance and Repair



Software Updates



Exchange Service



IQ/OQ Documents



Calibration Service



Spare Part Service



Moving Service

### TRAINING



Training



Comprehensive Instrument and Method Training

### LABORATORY



Application Service and Contract Testing

The owner-managed NETZSCH Group is a leading global technology company specializing in mechanical, plant and instrument engineering.

Under the management of Erich NETZSCH B.V. & Co. Holding KG, the company consists of the three business units Analyzing & Testing, Grinding & Dispersing and Pumps & Systems, which are geared towards specific industries and products. A worldwide sales and service network has guaranteed customer proximity and competent service since 1873.

When it comes to Thermal Analysis, Calorimetry (adiabatic & reaction), the determination of Thermophysical Properties, Rheology and Fire Testing, NETZSCH has it covered. Our 60 years of applications experience, broad state-of-the-art product line and comprehensive service offerings ensure that our solutions will not only meet your every requirement but also exceed your every expectation.

# Proven Excellence. ■

NETZSCH-Gerätebau GmbH  
Wittelsbacherstraße 42  
95100 Selb, Germany  
Tel.: +49 9287 881-0  
Fax: +49 9287 881-505  
at@netzsch.com  
<https://analyzing-testing.netzsch.com>



**NETZSCH**®

[www.netzsch.com](http://www.netzsch.com)