

**NETZSCH**

Proven Excellence.



## Accessories for Dilatometers and Thermomechanical Analyzers

Sample Holders, Spare Parts and Calibration Materials

Analyzing & Testing

# Introduction

The various methods of Thermal Analysis are widely used in many different industries to determine the properties of just about any material as a function of temperature. One interesting method is to measure the expansion or shrinkage of a material while it is subjected to a controlled temperature program. This allows for the analysis of phase transitions such as glass transitions in polymers, of the calculation of density change based on the measured thermal expansion especially for the transition from solid to liquid in metals and of the sintering processes in ceramics, among others.

With a dilatometer, the expansion or shrinkage of a sample is measured under a negligible load. A TMA (thermomechanical analyzer) measures the dimensional changes of a material under a defined load.

All dilatometers and TMA instruments offered by NETZSCH are listed in this catalog, together with all of our corresponding sample holders, accessories, and calibration materials. The many various possible combinations of these will allow you to optimally adapt your instrument to your samples and applications.

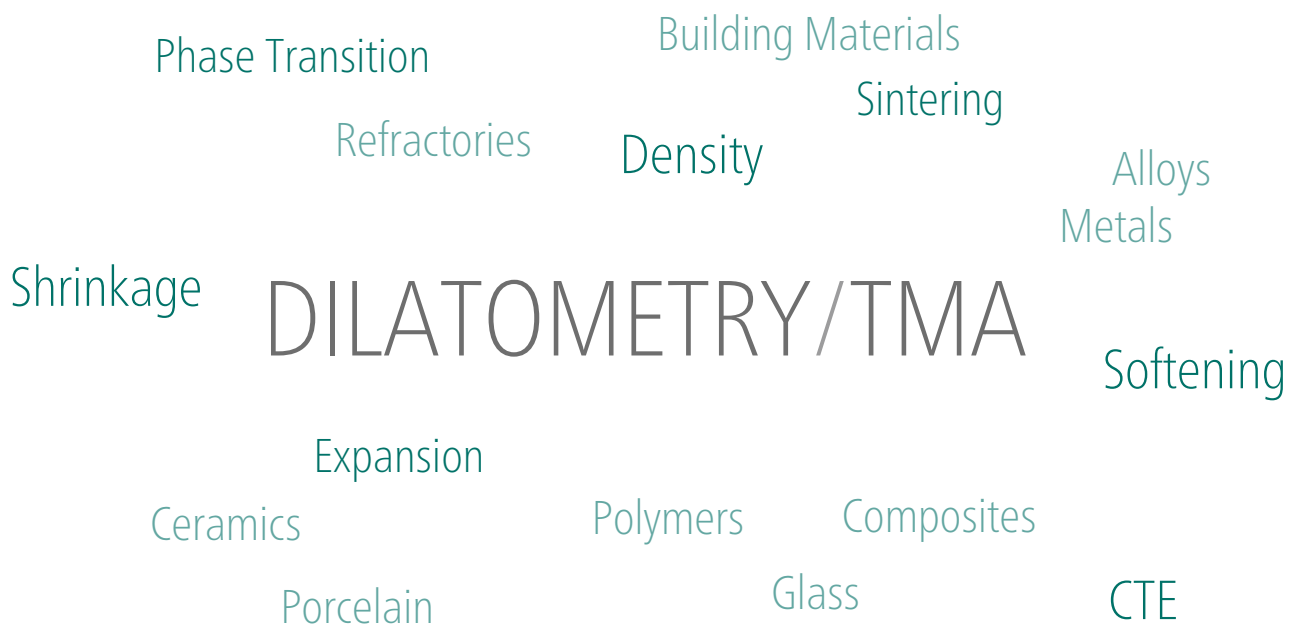

# TABLE OF CONTENTS

## Dilatometer DIL 402 *Expedis Classic*

Tube Sample Holders .....	4
Pushrods, Thermocouples and Thermocouple Holding Segments .....	6
Sample-Supporting Kits .....	7
Slides .....	8
Protective Tubes .....	9

## Dilatometer DIL 402 *Expedis Select*

Tube Sample Holders .....	10
Pushrods, Thermocouples and Thermocouple Holding Segments .....	12
Sample-Supporting Kits .....	13
Slides and Protective Tubes .....	15

## Dilatometers DIL 402 *Expedis Supreme* and DIL 402 *Expedis Supreme HT*

Tube Sample Holders .....	16
Slides and Sample-Supporting Kits .....	19
Pushrods, Thermocouples, Thermocouple Holding Segments .....	21
Protective Tubes .....	23

## Dilatometer DIL 402 *Expedis Accessories*

Sample Holders for Tension Measurements .....	24
Oxygen Trap System (OTS®) .....	25
Sample Holders and Containers for Special Applications .....	26
Protective Sleeves and Spacers .....	27

## Dilatometer DIL 402 E

Sample Holders .....	28
Pushrods and Protective Sleeves .....	30
Spacers and Sample Containers .....	31
Thermocouples, Furnaces and Protective Tubes .....	32

## Thermomechanical Analyzer TMA 402 *F1/F3 Hyperion*®

Measuring Modes and Fixture Sets for Expansion, Penetration, Tension, 3-Point Bending .....	35
Sample Fixture Sets .....	37
Support Tubes .....	40
Compatibility Matrix for Sample Holders with Furnaces .....	42
Spacers, Support Tube Caps .....	43
Pushrods and Pushrod Caps .....	44
Thermocouples .....	47
Clamps .....	48
Accessoires .....	50
Sample Containers .....	52

## Calibration Materials

Calibration Materials .....	55
Accessories .....	57

DIL 402 *Expedis Classic*

DIL 402 *Expedis Select*

DIL 402 *Expedis Supreme (HT)*

DIL 402 E

TMA 402 *F1/F3 Hyperion*®

# DIL 402 *Expedis Classic*



DIL 402 *Expedis Classic* with SiO<sub>2</sub> furnace

The DIL 402 *Expedis Classic* can operate in the temperature range from room temperature to 1600°C. It is available as a single or double measuring system (which can be used in double or differential mode).

In order to optimally adjust to the desired application, a variety of sample holders is available in different materials and sizes. Sample holders and accessories available for the DIL 402 *Expedis Classic* are listed in the following tables.

## Tube Sample Holders

All tube sample holder kits consist of holding tube with metal bush, slide, pushrod, thermocouple holding segment, thermocouple and a set of sample supports. They are available for single or double measuring systems.

### Tube Sample Holder Kits for Single Measuring System – Complete

Material	Sample Length (max.)	Sample Ø (max.)	Temperature (max.)	Set of Sample Supports Included	Thermo-couple	Order Number
Al <sub>2</sub> O <sub>3</sub>	52 mm	12 mm	1600°C	4, 6, 8 mm	Type S	DIL40200A60.000-00
Al <sub>2</sub> O <sub>3</sub>	52 mm	19 mm	1550/1600°C <sup>1</sup>	6, 12.7, 15 mm	Type S	DIL40200A70.000-00
Fused Silica	52 mm	12 mm	1100°C	4, 6, 8 mm	Type S	DIL40200A64.000-00
Fused Silica	52 mm	19 mm	1100°C	6, 12.7, 15 mm	Type S	DIL40200A71.000-00

<sup>1</sup> Temperature limited to 1550°C for sample diameters of 15 mm and 19 mm. This is because of the risk of sample holder lowering as stiffness decreases with increasing temperature.



Tube sample holder kit made of alumina for single measuring system (order no. DIL40200A60.000-00)



Tube sample holder kit made of fused silica for single measuring system (order no. DIL40200A64.000-00)

### Tube Sample Holder Kits for Double Measuring System – Complete

Material	Sample Length (max.)	Sample Ø (max.)	Temperature (max.)	Set of Sample Supports Included	Thermocouple	Order Number
Al <sub>2</sub> O <sub>3</sub>	52 mm	8 mm	1600°C	4, 6, 8 mm	Type S	DIL40200A61.000-00
Fused Silica	52 mm	8 mm	1100°C	4, 6, 8 mm	Type S	DIL40200A65.000-00



Tube sample holder kit made of alumina for double measuring system (order no. DIL40200A61.000-00)

### Tube Sample Holders for Single Measuring System – without Thermocouple, Pushrod or Sample Supports

Material	Sample Length (max.)	Sample Ø (max.)	Temperature (max.)	Spare Parts for Tube Sample Holder Kit	Order Number
Al <sub>2</sub> O <sub>3</sub>	52 mm	12 mm	1600°C	DIL40200A60.000-00	DIL40200A60.010-00
Al <sub>2</sub> O <sub>3</sub>	52 mm	19 mm	1550/1600°C <sup>1</sup>	DIL40200A70.000-00	DIL40200A70.010-00
Fused Silica	52 mm	12 mm	1100°C	DIL40200A64.000-00	DIL40200A64.010-00
Fused Silica	52 mm	19 mm	1100°C	DIL40200A71.000-00	DIL40200A71.010-00

<sup>1</sup> Temperature limited to 1550°C for sample diameters of 15 mm and 19 mm. This is because of the risk of sample holder lowering as stiffness decreases with increasing temperature.

### Tube Sample Holders for Double Measuring System – without Thermocouple, Pushrod or Sample Supports

Material	Sample Length (max.)	Sample Ø (max.)	Temperature (max.)	Spare Parts for Tube Sample Holder Kit	Order Number
Al <sub>2</sub> O <sub>3</sub>	52 mm	8 mm	1600°C	DIL40200A61.000-00	DIL40200A61.010-00
Fused Silica	52 mm	8 mm	1100°C	DIL40200A65.000-00	DIL40200A65.010-00



Tube sample holder made of alumina for single measuring system (order no. DIL40200A70.010-00)



Tube sample holder made of fused silica for double measuring system (order no. DIL40200A65.010-00)

## Pushrods, Thermocouples and Thermocouple Holding Segments

### Pushrods

Material	Sample Length (min.)	Sample Length (max.)	Rod Ø	Temperature (max.)	Order Number
Al <sub>2</sub> O <sub>3</sub>	0	52 mm	4 mm	1600°C	DIL40200A60.030-00
Fused Silica	0	52 mm	4 mm	1100°C	DIL40200A64.030-00
Fused Silica <sup>1</sup>	0	52 mm	4 mm	1100°C	DIL40200A64.040-00

<sup>1</sup> For samples less than ø 2.5 mm



Pushrods made of alumina (order no. DIL40200A60.030-00) and fused silica (order no. DIL40200A64.030-00)

### Sample Thermocouples with Connector

Type	Temperature Range	Order Number
S	RT ... 1600°C	DIL40200A60.020-00
Protection cap for thermocouples	Made of Al <sub>2</sub> O <sub>3</sub> , closed on one end	NGB801726



Thermocouple Type S and connector (order no. DIL40200A60.020-00) with protection cap (order no. NGB801726)

### Thermocouple Holding Segments

Material	Tube Ø	Measuring System	For Tube Sample Holder	Order Number
Al <sub>2</sub> O <sub>3</sub>	12 mm	Single	DIL40200A60.000-00	NGB815456
Al <sub>2</sub> O <sub>3</sub>	19 mm	Single	DIL40200A70.000-00	NGB815836
Al <sub>2</sub> O <sub>3</sub>	19 mm	Double	DIL40200A61.000-00	NGB815452
Fused Silica	12 mm	Single	DIL40200A64.000-00	NGB815603
Fused Silica	19 mm	Single	DIL40200A71.000-00	NGB815832
Fused Silica	19 mm	Double	DIL40200A65.000-00	NGB815600

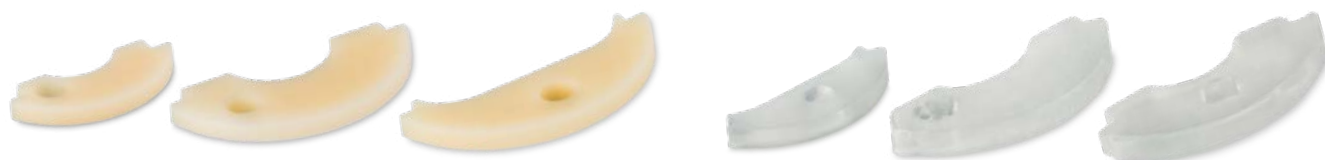

Thermocouple holding segments made in different sizes

## Sample-Supporting Kits (2-piece set)

The sample-supporting kits for the tube sample holders come in different materials and sizes, allowing for samples of various diameters to be measured over a wide temperature range.

### Sample-Supporting Kits for Single Measuring System Made of Alumina

Sample Ø	Tube Ø	For Tube Sample Holder	Order Number
4 mm	12 mm	DIL40200A60.000-00	6.219.1-40.4.00
6 mm	12 mm	DIL40200A60.000-00	6.219.1-40.5.00
8 mm	12 mm	DIL40200A60.000-00	6.219.1-40.6.00
6 mm	19 mm	DIL40200A70.000-00	6.219.3-87.5.00
12.7 mm	19 mm	DIL40200A70.000-00	DIL40200A70.040-00
15 mm	19 mm	DIL40200A70.000-00	DIL40200A70.050-00



Sample-supporting kits made of alumina

### Sample-Supporting Kits for Single Measuring System Made of Fused Silica

Sample Ø	Tube Ø	For Tube Sample Holder	Order Number
2 mm <sup>1</sup>	12 mm	DIL40200A64.000-00	DIL40200A64.050-00
4 mm	12 mm	DIL40200A64.000-00	6.219.1-41.4.00
6 mm	12 mm	DIL40200A64.000-00	6.219.1-41.5.00
8 mm	12 mm	DIL40200A64.000-00	6.219.1-41.6.00
6 mm	19 mm	DIL40200A71.000-00	6.219.1-45.2.00
12.7 mm	19 mm	DIL40200A71.000-00	DIL40200A71.040-00
15 mm	19 mm	DIL40200A71.000-00	DIL40200A71.050-00

<sup>1</sup> For the use with pushrod DIL40200A64.040-00



Sample-supporting kits made of fused silica

### Sample-Supporting Kits for Double Measuring System Made of Alumina

Sample Ø	For Tube Sample Holder	Order Number
4 mm	DIL40200A61.000-00	DIL40200A61.030-00
6 mm	DIL40200A61.000-00	DIL40200A61.040-00
8 mm	DIL40200A61.000-00	DIL40200A61.050-00

### Sample-Supporting Kits for Double Measuring System Made of Fused Silica

Sample Ø	For Tube Sample Holder	Order Number
4 mm	DIL40200A65.000-00	DIL40200A65.030-00
6 mm	DIL40200A65.000-00	DIL40200A65.040-00
8 mm	DIL40200A65.000-00	DIL40200A65.050-00

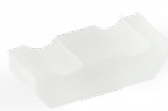

Sample-supporting kits made of alumina and fused silica for double measuring system

## Slides for Sample Holders

Slides protect sample holders from damage by sticking samples. Slides for the double measuring system are the same as those for the 19-mm tube of the single measuring system.

### Slides for Tube Sample Holders

Material	Tube Ø	For Tube Sample Holder	Order Number
Al <sub>2</sub> O <sub>3</sub>	12 mm	DIL40200A60.000-00	GB395367
Al <sub>2</sub> O <sub>3</sub>	19 mm	DIL40200A70.000-00 and DIL40200A61.000-00	NGB804526
Fused Silica	12 mm	DIL40200A64.000-00	GB453664
Fused Silica	19 mm	DIL40200A71.000-00 and DIL40200A65.000-00	NGB800434



Slides made of alumina and fused silica in different sizes



## Protective Tubes

Exchangeable protective tubes are used in order to protect the furnace from any possible reactions by the sample or from the release of chemicals during heating.

Protective Tubes			
Material	For Furnace	Temperature (max.)	Order Number
$\text{Al}_2\text{O}_3$	High-temperature tube furnaces with exchangeable SiC heating element (DIL40200A84.000-00 and DIL40200A84.500-00)	1600°C	6.219.1-71.1.00
Fused Silica		1100°C	6.219.1-71.2.00



Protective tube made of alumina (order no. 6.219.1-71.1.00)



Protective tube made of fused silica (order no. 6.219.1-71.2.00)

## Determination of the Softening Point of a Borosilicate Glass

The length change of a borosilicate glass sample was measured with the DIL 402 *Expedis Classic*. The sample had an initial length of 14.89 mm and was heated from room temperature up to 770°C at a controlled heating rate of 5 K/min. The change in the slope of the dilatation curve at 551°C (onset temperature) indicates the glass transition of the borosilicate glass. The peak measured at 667°C (peak temperature) corresponds to its dilatometric softening point.

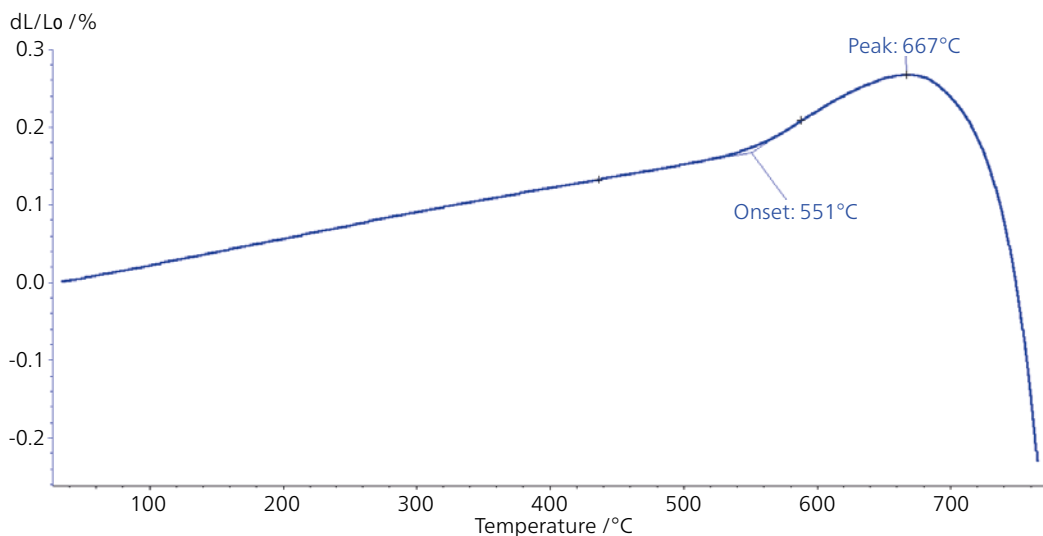

Change of the expansion behavior of a borosilicate glass during glass transition and softening

# DIL 402 *Expedis Select*



DIL 402 *Expedis Select* with SiC furnace (front) and low-temperature furnace (rear)

With its double furnace guidance, the DIL 402 *Expedis Select* can operate in the temperature range from -180°C to 1600°C. It is available as a single or double measuring system (which can be used in double or differential mode). In order to optimally adjust to the desired application, a variety of sample holders is available in different materials and sizes. Sample holders and accessories available for the DIL 402 *Expedis Select* are listed in the following tables.

## Tube Sample Holders

All tube sample holder kits consist of a holding tube with metal bush, slide, pushrod, thermocouple holding segment, thermocouple and a set of sample supports. They are available for single or double measuring systems.

### Tube Sample Holder Kits for Single Measuring System – Complete

Material	Sample Length (max.)	Sample Ø (max.)	Temperature (max.)	Set of Sample Supports Included	Thermo-couple	Order Number
Al <sub>2</sub> O <sub>3</sub>	52 mm	12 mm	1600°C	4, 6, 8 mm	Type S	DIL40200A60.000-00
Al <sub>2</sub> O <sub>3</sub> <sup>1</sup>	52 mm	12 mm	1680°C	4, 6, 8 mm	Type B	DIL40200A62.000-00
Al <sub>2</sub> O <sub>3</sub>	52 mm	19 mm	1550/1600°C <sup>2</sup>	6, 12.7, 15 mm	Type S	DIL40200A70.000-00
Fused Silica	52 mm	12 mm	1100°C	4, 6, 8 mm	Type S	DIL40200A64.000-00
Fused Silica	52 mm	12 mm	1000°C	4, 6, 8 mm	Type K	DIL40200A66.000-00
Fused Silica	52 mm	19 mm	1100°C	6, 12.7, 15 mm	Type S	DIL40200A71.000-00
Fused Silica	52 mm	19 mm	1000°C	6, 12.7, 15 mm	Type K	DIL40200A52.000-00

<sup>1</sup> Highly sintered alumina

<sup>2</sup> Temperature limited to 1550°C for sample diameters of 15 mm and 19 mm. This is because of the risk of sample holder lowering as stiffness decreases with increasing temperature.

## Tube Sample Holder Kits for Double Measuring System – Complete

Material	Sample Length (max.)	Sample Ø (max.)	Temperature (max.)	Set of Sample Supports Included	Thermocouple	Order Number
Al <sub>2</sub> O <sub>3</sub>	52 mm	8 mm	1600°C	4, 6, 8 mm	Type S	DIL40200A61.000-00
Fused Silica	52 mm	8 mm	1100°C	4, 6, 8 mm	Type S	DIL40200A65.000-00
Fused Silica	52 mm	8 mm	1000°C	4, 6, 8 mm	Type K	DIL40200A67.000-00



Tube sample holder kit made of fused silica for single measuring system (order no. DIL40200A64.000-00)



Tube sample holder kit made of alumina (order no. DIL40200A60.000-00)

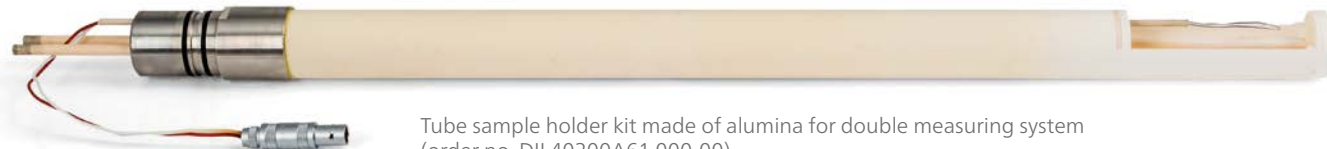

Tube sample holder kit made of alumina for double measuring system (order no. DIL40200A61.000-00)

## Tube Sample Holders for Single Measuring System – without Thermocouple, Pushrod and Sample Supports

Material	Sample Length (max.)	Sample Ø (max.)	Temperature (max.)	Spare Part for Tube Sample Holder Kit	Order Number
Al <sub>2</sub> O <sub>3</sub>	52 mm	12 mm	1600°C	DIL40200A60.000-00	DIL40200A60.010-00
Al <sub>2</sub> O <sub>3</sub> <sup>1</sup>	52 mm	12 mm	1680°C	DIL40200A62.000-00	DIL40200A62.010-00
Al <sub>2</sub> O <sub>3</sub>	52 mm	19 mm	1550/1600°C <sup>2</sup>	DIL40200A70.000-00	DIL40200A70.010-00
Fused Silica	52 mm	12 mm	1100°C	DIL40200A64.000-00 and DIL40200A66.000-00	DIL40200A64.010-00
Fused Silica	52 mm	19 mm	1100°C	DIL40200A71.000-00	DIL40200A71.010-00

<sup>1</sup> Highly sintered alumina

<sup>2</sup> Temperature limited to 1550°C for sample diameters of 15 mm and 19 mm. This is because of the risk of sample holder lowering as stiffness decreases with increasing temperature.

## Tube Sample Holders for Double Measuring System – without Thermocouple, Pushrod and Sample Supports

Material	Sample Length (max.)	Sample Ø (max.)	Temperature (max.)	Spare Part for Tube Sample Holder Kit	Order Number
Al <sub>2</sub> O <sub>3</sub>	52 mm	8 mm	1600°C	DIL40200A61.000-00	DIL40200A61.010-00
Fused Silica	52 mm	8 mm	1100°C	DIL40200A65.000-00 and DIL40200A67.000-00	DIL40200A65.010-00



Tube sample holder made of alumina for single measuring system (order no. DIL40200A70.010-00)



Tube sample holder made of fused silica for double measuring system (order no. DIL40200A65.010-00)

## Pushrods, Thermocouples and Thermocouple Holding Segments

### Pushrods

Material	Sample Length (min.)	Sample Length (max.)	Rod Ø	Temperature (max.)	Order Number
Al <sub>2</sub> O <sub>3</sub>	0	52 mm	4 mm	1600°C	DIL40200A60.030-00
Al <sub>2</sub> O <sub>3</sub> <sup>1</sup>	0	52 mm	4 mm	1680°C	DIL40200A62.030-00
Fused Silica	0	52 mm	4 mm	1100°C	DIL40200A64.030-00
Fused Silica <sup>2</sup>	0	52 mm	4 mm	1100°C	DIL40200A64.040-00

<sup>1</sup> Highly sintered alumina

<sup>2</sup> For samples less than ø 2.5 mm



Pushrods made of alumina (order no. DIL40200A60.030-00) and fused silica (order no. DIL40200A64.030-00)

### Sample Thermocouples with Connector

Type	Temperature Range	Order Number
S	RT ... 1600°C	DIL40200A60.020-00
B	RT ... 1680°C	DIL40200A62.020-00
K	-180 ... 1000°C	DIL40200A66.020-00
D <sup>1</sup>	RT ... 1680°C	DIL40200A60.040-00
Protection cap for thermocouples	Made of Al <sub>2</sub> O <sub>3</sub> , closed on one end	NGB801726

<sup>1</sup> W3%Re-W25%Re



Thermocouple Type S and connector (order no. DIL40200A60.020-00) with protection cap (order no. NGB801726)

## Thermocouple Holding Segments

Material	Tube Ø	Measuring System	For Tube Sample Holder	Order Number
Al <sub>2</sub> O <sub>3</sub>	12 mm	Single	DIL40200A60.000-00, DIL40200A62.000-00	NGB815456
Al <sub>2</sub> O <sub>3</sub>	19 mm	Single	DIL40200A70.000-00	NGB815836
Al <sub>2</sub> O <sub>3</sub>	19 mm	Double	DIL40200A61.000-00	NGB815452
Fused Silica	12 mm	Single	DIL40200A64.000-00, DIL40200A66.000-00	NGB815603
Fused Silica	19 mm	Single	DIL40200A71.000-00	NGB815832
Fused Silica	19 mm	Double	DIL40200A65.000-00, DIL40200A67.000-00	NGB815600



Thermocouple holding segments of alumina and fused silica in different sizes

## Sample-Supporting Kits (2-piece set)

The sample-supporting kits for the tube sample holders come in different materials and sizes, allowing for samples of various diameters to be measured in the high-temperature range. Every kit comes as a pair of sample supports.

### Sample-Supporting Kits for Single Measuring System Made of Alumina

Sample Ø	Tube Ø	For Tube Sample Holder	Order Number
4 mm	12 mm	DIL40200A60.000-00 and DIL40200A62.000-00	6.219.1-40.4.00
6 mm	12 mm	DIL40200A60.000-00 and DIL40200A62.000-00	6.219.1-40.5.00
8 mm	12 mm	DIL40200A60.000-00 and DIL40200A62.000-00	6.219.1-40.6.00
6 mm	19 mm	DIL40200A70.000-00	6.219.3-87.5.00
12.7 mm	19 mm	DIL40200A70.000-00	DIL40200A70.040-00
15 mm	19 mm	DIL40200A70.000-00	DIL40200A70.050-00



Sample-supporting kits made of alumina

### Sample-Supporting Kits for Single Measuring System Made of Fused Silica

Sample Ø	Tube Ø	For Tube Sample Holder	Order Number
2 mm <sup>1</sup>	12 mm	DIL40200A64.000-00 and DIL40200A66.000-0	DIL40200A64.050-00
4 mm	12 mm	DIL40200A64.000-00 and DIL40200A66.000-00	6.219.1-41.4.00
6 mm	12 mm	DIL40200A64.000-00 and DIL40200A66.000-00	6.219.1-41.5.00
8 mm	12 mm	DIL40200A64.000-00 and DIL40200A66.000-00	6.219.1-41.6.00
6 mm	19 mm	DIL40200A71.000-00	6.219.1-45.2.00
12.7 mm	19 mm	DIL40200A71.000-00	DIL40200A71.040-00
15 mm	19 mm	DIL40200A71.000-00	DIL40200A71.050-00

<sup>1</sup> For the use with pushrod DIL40200A64.040-00



Sample-supporting kits made of fused silica

### Sample-Supporting Kits Made of Al<sub>2</sub>O<sub>3</sub> for Double Measuring System

Sample Ø	For Tube Sample Holder	Order Number
4 mm	DIL40200A61.000-00	DIL40200A61.030-00
6 mm	DIL40200A61.000-00	DIL40200A61.040-00
8 mm	DIL40200A61.000-00	DIL40200A61.050-00

### Sample-Supporting Kits Made of Fused Silica for Double Measuring System

Sample Ø	For Tube Sample Holder	Order Number
4 mm	DIL40200A65.000-00 and DIL40200A67.000-00	DIL40200A65.030-00
6 mm	DIL40200A65.000-00 and DIL40200A67.000-00	DIL40200A65.040-00
8 mm	DIL40200A65.000-00 and DIL40200A67.000-00	DIL40200A65.050-00



Sample-supporting kits made of alumina and fused silica for double measuring system

## Slides for Sample Holders

Slides protect sample holders from damage by sticking samples. They are available in fused silica and alumina. The slides for the double measuring system are the same as those for the 19-mm tube of the single measuring system.

### Slides for Tube Sample Holders

Material	Tube Ø	For Tube Sample Holder	Order Number
Al <sub>2</sub> O <sub>3</sub>	12 mm	DIL40200A60.000-00 and DIL40200A62.000-00	GB395367
Al <sub>2</sub> O <sub>3</sub>	19 mm	DIL40200A70.000-00 and DIL40200A61.000-00	NGB804526
Fused Silica	12 mm	DIL40200A64.000-00 and DIL40200A66.000-00	GB453664
Fused Silica	19 mm	DIL40200A71.000-00, DIL40200A65.000-00 and DIL40200A67.000-00	NGB800434



Slides made of alumina and fused silica in different sizes

## Protective Tubes

Exchangeable protective tubes are used in order to protect the furnace from any possible reactions by the sample or from the release of chemicals during heating.

### Protective Tubes

Material	For Furnace	Temperature (max.)	Order Number
Al <sub>2</sub> O <sub>3</sub>	High-temperature tube furnaces with exchangeable SiC heating element	1650°C	6.219.1-71.1.00
Fused Silica	(DIL40200A84.000-00 and DIL40200A84.500-00)	1100°C	6.219.1-71.2.00



Protective tube made of alumina (order no. 6.219.1-71.1.00)



Protective tube made of fused silica (order no. 6.219.1-71.2.00)

# DIL 402 *Expedis Supreme* and DIL 402 *Expedis Supreme HT*



DIL 402 *Expedis Supreme* with SiC furnace (front) and low-temperature furnace (rear)

With the double furnace guidance of the DIL 402 *Expedis Supreme*, a temperature range from -180°C to 2000°C can be covered. The DIL 402 *Expedis Supreme* is available as a single or double measuring system (which can be used in double or differential mode). DIL 402 *Expedis Supreme HT* is equipped with a pyrometer allowing for measurements up to 2800°C with a single or double measurement system. In order to optimally adjust to the desired application, a variety of sample holders can be used in different materials and sizes. Sample holders and accessories available for the DIL 402 *Expedis Supreme* and *Supreme HT* are listed in the following tables.

## Tube Sample Holders

All tube sample holder kits consist of a holding tube with metal bush, slide, pushrod, thermocouple holding segment, thermocouple and a set of sample supports. They are available for single or double measuring systems.

### Tube Sample Holder Kits for Single Measuring System – Complete

Material	Sample Length (max.)	Sample Ø (max.)	Temperature (max.)	Set of Sample Supports Included	Thermocouple	Order Number
Al <sub>2</sub> O <sub>3</sub>	52 mm	12 mm	1600°C	4, 6, 8 mm	Type S	DIL40200A60.000-00
Al <sub>2</sub> O <sub>3</sub> <sup>1</sup>	52 mm	12 mm	1680°C	4, 6, 8 mm	Type B	DIL40200A62.000-00
Al <sub>2</sub> O <sub>3</sub> <sup>1</sup>	52 mm	12 mm	1680°C	4, 6, 8 mm	Type S	DIL40200A50.000-00
Al <sub>2</sub> O <sub>3</sub>	52 mm	19 mm	1550/1600°C <sup>2</sup>	6, 12.7, 15 mm	Type S	DIL40200A70.000-00
Fused Silica	52 mm	12 mm	1100°C	4, 6, 8 mm	Type S	DIL40200A64.000-00
Fused Silica	52 mm	12 mm	1000°C	4, 6, 8 mm	Type K	DIL40200A66.000-00
Fused Silica	52 mm	19 mm	1100°C	6, 12.7, 15 mm	Type S	DIL40200A71.000-00
Fused Silica	52 mm	19 mm	1100°C	6, 12.7, 15 mm	Type K	DIL40200A52.000-00
Graphite	52 mm <sup>3</sup>	6 mm	2000°C	4, 6 mm	Type D <sup>4</sup>	DIL40200A68.000-00
Graphite <sup>5</sup>	52 mm <sup>3</sup>	6 mm	2000°C	4, 6 mm	Type D <sup>4</sup>	DIL40200A78.000-00
Graphite	52 mm <sup>3</sup>	19 mm	2000°C	6, 12.7, 15 mm	Type D <sup>4</sup>	DIL40200A72.000-00
Graphite	52 mm <sup>3</sup>	12 mm	2800°C, pyrometer mode	4, 6, 8 mm	Type D <sup>4</sup>	DIL40200A77.000-00
Graphite	52 mm <sup>3</sup>	19 mm	2800°C, pyrometer mode	6, 12.7, 15 mm	Type D <sup>4</sup>	DIL40200A55.000-00

<sup>1</sup> Highly sintered alumina

<sup>2</sup> Temperature limited to 1550°C for sample diameters of 15 mm and 19 mm. This is because of the risk of sample holder lowering as stiffness decreases with increasing temperature.

<sup>3</sup> The longitudinal temperature distribution is optimized to the available standard samples of maximum 25 mm

<sup>4</sup> W3%Re-W25%Re

<sup>5</sup> With sheathed thermocouple; sheath made of molybdenum



## Tube Sample Holder Kits for Double Measuring System – Complete

Material	Sample Length (max.)	Sample Ø (max.)	Temperature (max.)	Set of Sample Supports Included	Thermocouple	Order Number
Al <sub>2</sub> O <sub>3</sub>	52 mm	8 mm	1600°C	4, 6, 8 mm	Type S	DIL40200A61.000-00
Fused Silica	52 mm	8 mm	1000°C	4, 6, 8 mm	Type K	DIL40200A67.000-00
Fused Silica	52 mm	8 mm	1100°C	4, 6, 8 mm	Type S	DIL40200A65.000-00
Graphite	52 mm <sup>1</sup>	8 mm	2000°C	4, 6, 8 mm	Type D <sup>2</sup>	DIL40200A69.000-00
Graphite	52 mm <sup>1</sup>	8 mm	2800°C	4, 6, 8 mm	Type D <sup>2</sup> (safety thermocouple)	DIL40200A51.000-00
Graphite	52 mm	8 mm	2000°C	4, 6, 8 mm	Type D <sup>2,3</sup>	DIL40200A79.000-00

<sup>1</sup> The longitudinal temperature distribution is optimized to the available standard samples of maximum 25 mm

<sup>2</sup> W3%Re-W25%Re

<sup>3</sup> With sheathed thermocouple; sheath made of molybdenum



Tube sample holder kit made of graphite for single measuring system (order no. DIL40200A68.000-00)

Tube sample holder kit made of alumina for single measuring system (order no. DIL40200A60.000-00)

## Tube Sample Holders for Single Measuring System – without Thermocouple, Pushrod and Sample Supports

Material	Sample Length (max.)	Sample Ø (max.)	Temperature (max.)	Spare Part for Tube Sample Holder Kit	Order Number
Al <sub>2</sub> O <sub>3</sub>	52 mm	12 mm	1600°C	DIL40200A60.000-00	DIL40200A60.010-00
Al <sub>2</sub> O <sub>3</sub> <sup>1</sup>	52 mm	12 mm	1680°C	DIL40200A62.000-00 and DIL40200A50.000-00	DIL40200A62.010-00
Al <sub>2</sub> O <sub>3</sub>	52 mm	19 mm	1550/1600°C <sup>2</sup>	DIL40200A70.000-00	DIL40200A70.010-00
Fused Silica	52 mm	12 mm	1100°C	DIL40200A64.000-00 and DIL40200A66.000-00	DIL40200A64.010-00
Fused Silica	52 mm	19 mm	1100°C	DIL40200A71.000-00 and DIL40200A52.000-00	DIL40200A71.010-00
Graphite <sup>3</sup>	52 mm <sup>5</sup>	6 mm	2800°C	DIL40200A68.000-00 and DIL40200A77.000-00	DIL40200A68.010-00
Graphite <sup>4</sup>	52 mm <sup>5</sup>	6 mm	2000°C	DIL40200A78.000-00	DIL40200A78.010-00
Graphite <sup>3</sup>	52 mm <sup>5</sup>	19 mm	2800°C	DIL40200A72.000-00 and DIL40200A55.000-00	DIL40200A72.010-00

<sup>1</sup> Highly sintered alumina

<sup>2</sup> Temperature limited to 1550°C for sample diameters of 15 mm and 19 mm. This is because of the risk of sample holder lowering as stiffness decreases with increasing temperature.

<sup>3</sup> Thermocouple Holding Segment not included

<sup>4</sup> Sheathed thermocouple Type D with sheath of molybdenum included

<sup>5</sup> The longitudinal temperature distribution is optimized to the available standard samples of maximum 25 mm

### Tube Sample Holders for Double Measuring System – without Thermocouple, Pushrod and Sample Supports

Material	Sample Length (max.)	Sample Ø (max.)	Temperature (max.)	Spare Part for Tube Sample Holder Kit	Order Number
Al <sub>2</sub> O <sub>3</sub>	52 mm	8 mm	1600°C	DIL40200A61.000-00	DIL40200A61.010-00
Fused Silica	52 mm	8 mm	1100°C	DIL40200A65.000-00 and DIL40200A67.000-00	DIL40200A65.010-00
Graphite <sup>1</sup>	52 mm <sup>2</sup>	8 mm	2800°C	DIL40200A69.000-00 and DIL40200A51.000-00	DIL40200A69.010-00
Graphite <sup>3</sup>	52 mm <sup>2</sup>	8 mm	2000°C	DIL40200A79.000-00	DIL40200A79.010-00

<sup>1</sup> Thermocouple Holding Segment is not included

<sup>2</sup> The longitudinal temperature distribution is optimized to the available standard samples of maximum 25 mm

<sup>3</sup> Sheathed thermocouple Type D with sheath of molybdenum included



Tube sample holder made of alumina for single measuring system  
(order no. DIL40200A70.010-00)



Tube sample holder made of fused silica for double measuring system  
(order no. DIL40200A65.010-00)



Tube sample holder made of graphite for single measuring system with type D thermocouple  
(order no. DIL40200A650.010-00 (thermocouple not included))

## Slides for Sample Holders

Slides protect sample holders from damage by sticking samples. The slides for the double measuring system are the same as those for the 19-mm tube of the single measuring system.

### Slides for Tube Sample Holders

Material	Tube Ø	For Tube Sample Holder	Order Number
Al <sub>2</sub> O <sub>3</sub>	12 mm	DIL40200A60.000-00, DIL40200A62.000-00 and DIL40200A50.000-00	GB395367
Al <sub>2</sub> O <sub>3</sub>	19 mm	DIL40200A70.000-00 and DIL40200A61.000-00	NGB804526
Fused Silica	12 mm	DIL40200A64.000-00 and DIL40200A66.000-00	GB453664
Fused Silica	19 mm	DIL40200A71.000-00, DIL40200A65.000-00, DIL40200A67.000-00 and DIL40200A52.000-00	NGB800434
Graphite	12 mm	DIL40200A68.000-00, DIL40200A78.000-00 and DIL40200A77.000-00	NGB803672
Graphite	19 mm	DIL40200A69.000-00, DIL40200A72.000-00, DIL40200A79.000-00, DIL402A55.000-00 and DIL40200A51.000-00	NGB810634

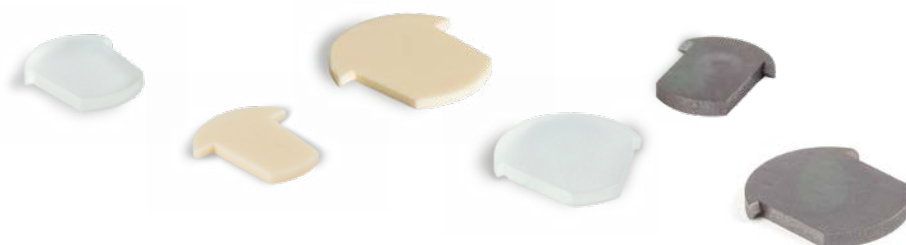

Slides made of fused silica, alumina and graphite in different sizes

## Sample-Supporting Kits (2-piece set)

The sample-supporting kits for the tube sample holders come in different materials and sizes, allowing for samples with various diameters to be measured over a wide temperature range.

### Sample-Supporting Kits for Single Measuring System Made of Alumina

Sample Ø	Tube Ø	For Tube Sample Holder	Order Number
4 mm	12 mm	DIL40200A60.000-00, DIL40200A62.000-00 and DIL40200A50.000-00	6.219.1-40.4.00
6 mm	12 mm	DIL40200A60.000-00, DIL40200A62.000-00 and DIL40200A50.000-00	6.219.1-40.5.00
8 mm	12 mm	DIL40200A60.000-00, DIL40200A62.000-00 and DIL40200A50.000-00	6.219.1-40.6.00
6 mm	19 mm	DIL40200A70.000-00	6.219.3-87.5.00
12.7 mm	19 mm	DIL40200A70.000-00	DIL40200A70.040-00
15 mm	19 mm	DIL40200A70.000-00	DIL40200A70.050-00

### Sample-Supporting Kits for Single Measuring System Made of Fused Silica

Sample Ø	Tube Ø	For Tube Sample Holder	Order Number
2 mm	12 mm	DIL40200A60.000-00, DIL40200A62.000-00 and DIL40200A50.000-00	DIL40200A64.050-00
4 mm	12 mm	DIL40200A60.000-00, DIL40200A62.000-00 and DIL40200A50.000-00	6.219.1-41.4.00
6 mm	12 mm	DIL40200A60.000-00, DIL40200A62.000-00 and DIL40200A50.000-00	6.219.1-41.5.00
8 mm	12 mm	DIL40200A60.000-00, DIL40200A62.000-00 and DIL40200A50.000-00	6.219.1-41.6.00
6 mm	19 mm	DIL40200A71.000-00 and DIL40200A52.000-00	6.219.1-45.2.00
12.7 mm	19 mm	DIL40200A71.000-00 and DIL40200A52.000-00	DIL40200A71.040-00
15 mm	19 mm	DIL40200A71.000-00 and DIL40200A52.000-00	DIL40200A71.050-00



### Sample-Supporting Kits for Single Measuring System Made of Graphite

Sample Ø	Tube Ø	For Tube Sample Holder	Order Number
4 mm	12 mm	DIL40200A68.000-00, DIL40200A78.000-00 and DIL40200A77.000-00	6.219.2-44.4.00
6 mm	12 mm	DIL40200A68.000-00, DIL40200A78.000-00 and DIL40200A77.000-00	6.219.2-44.5.00
6 mm	19 mm	DIL40200A72.000-00 and DIL40200A55.000-00	6.219.4-85.5.00
8 mm	12 mm	DIL40200A77.000-00	6.219.2-44.6.00
12.7 mm	19 mm	DIL40200A72.000-00 and DIL40200A55.000-00	DIL40200A72.040-00
15 mm	19 mm	DIL40200A72.000-00 and DIL40200A55.000-00	DIL40200A72.050-00

### Sample-Supporting Kits for Double Measuring System Made of Alumina

Sample Ø	Tube Ø	For Tube Sample Holder	Order Number
4 mm	19 mm	DIL40200A61.000-00	DIL40200A61.030-00
6 mm	19 mm	DIL40200A61.000-00	DIL40200A61.040-00
6 mm and min. length 40 mm	19 mm	DIL40200A61.000-00	NGB819811 <sup>1</sup>
8 mm	19 mm	DIL40200A61.000-00	DIL40200A61.050-00

<sup>1</sup> Single piece

### Sample-Supporting Kits for Double Measuring System Made of Fused Silica

Sample Ø	Tube Ø	For Tube Sample Holder	Order Number
4 mm	19 mm	DIL40200A65.000-00 and DIL40200A67.000-00	DIL40200A65.030-00
6 mm	19 mm	DIL40200A65.000-00 and DIL40200A67.000-00	DIL40200A65.040-00
8 mm	19 mm	DIL40200A65.000-00 and DIL40200A67.000-00	DIL40200A65.050-00

### Sample-Supporting Kits for Double Measuring System Made of Graphite

Sample Ø	Tube Ø	For Tube Sample Holder	Order Number
4 mm	19 mm	DIL40200A69.000-00, DIL40200A79.000-00 and DIL40200A51.000-00	DIL40200A69.030-00
6 mm	19 mm	DIL40200A69.000-00, DIL40200A79.000-00 and DIL40200A51.000-00	DIL40200A69.040-00
8 mm	19 mm	DIL40200A69.000-00, DIL40200A79.000-00 and DIL40200A51.000-00	DIL40200A69.050-00



Sample-supporting kits made of fused silica, alumina and graphite for double measuring system

## Pushrods, Thermocouples and Thermocouple Holding Segments

### Pushrods

Material	Sample Length (min.)	Sample Length (max.)	Rod Ø	Temperature (max.)	Order Number
Al <sub>2</sub> O <sub>3</sub>	0	52 mm	4 mm	1600°C	DIL40200A60.030-00
Al <sub>2</sub> O <sub>3</sub> <sup>1</sup>	0	52 mm	4 mm	1680°C	DIL40200A62.030-00
Fused Silica	0	52 mm	4 mm	1100°C	DIL40200A64.030-00
Fused Silica <sup>2</sup>	0	52 mm	4 mm	1100°C	DIL40200A64.040-00
Graphite	0	52 mm	4 mm	2800°C (inert)	DIL40200A68.030-00

<sup>1</sup> Highly sintered alumina

<sup>2</sup> For samples less than Ø 2.5 mm



Pushrods made of alumina (order no. DIL40200A60.030-00), fused silica (order no. DIL40200A64.030-00) and graphite (order no. DIL40200A68.030-00)

## Sample and Safety Thermocouples

Type	Temperature Range	Remark	Order Number
S	RT ... 1600°C	Sample thermocouple	DIL40200A60.020-00
B	RT ... 1680°C	Sample thermocouple	DIL40200A62.020-00
K	-180 ... 1000°C	Sample thermocouple	DIL40200A66.020-00
D <sup>1,3</sup>	RT ... 1680°C	Sample thermocouple	DIL40200A60.040-00
D <sup>1,4</sup>	RT ... 2000°C	Sample thermocouple	DIL40200A68.020-00
D <sup>1,2,4</sup>	RT ... 2000°C	Sample thermocouple	DIL40200A78.020-00
D <sup>1,4</sup>	RT ... 2800°C	Safety thermocouple	DIL40200A77.020-00

<sup>1</sup> W3%Re-W25%Re

<sup>2</sup> With sheath of molybdenum and connecting clip

<sup>3</sup> Can be used with fused silica and alumina sample holders

<sup>4</sup> Requires soldering during installation (order numbers DIL40200A68.020-00; DIL40200A78.020-00; DIL40200A77.020-00)



Thermocouple Type S and connector (order no. DIL40200A60.020-00) with protection cap (order no. NGB801726)

## Thermocouple Holding Segments

Material	Tube Ø	Measuring System	For Tube Sample Holder	Order Number
Al <sub>2</sub> O <sub>3</sub>	12 mm	Single	DIL40200A60.000-00, DIL40200A62.000-00, DIL40200A50.000-00	NGB815456
Al <sub>2</sub> O <sub>3</sub>	19 mm	Single	DIL40200A70.000-00	NGB815836
Al <sub>2</sub> O <sub>3</sub>	19 mm	Double	DIL40200A61.000-00	NGB815452
Fused Silica	12 mm	Single	DIL40200A64.000-00, DIL40200A66.000-00	NGB815603
Fused Silica	19 mm	Single	DIL40200A71.000-00, DIL40200A52.000-00	NGB815832
Fused Silica	19 mm	Double	DIL40200A65.000-00, DIL40200A67.000-00	NGB815600
Graphite	12 mm	Single	DIL40200A68.000-00	NGB807168
Graphite	19 mm	Single	DIL40200A72.000-00	NGB815882
Graphite	19 mm	Double	DIL40200A69.000-00	NGB815659
Connecting Clip made of molybdenum <sup>1</sup>	12 mm/19 mm	Single/Double	DIL40200A78.000-00, DIL40200A79.000-00	6.214.5-91.5.01

<sup>1</sup> For thermocouple type D with sheath of molybdenum



Thermocouple holding segments made of graphite, alumina and fused silica in different sizes

## Accessories for Furnaces

Exchangeable protective tubes are used in order to protect the furnace from any possible reactions by the sample or from the release of chemicals during heating.

Protective Tubes			
Material	For Furnace	Temperature (max.)	Order Number
Al <sub>2</sub> O <sub>3</sub>	High-temperature tube furnaces with exchangeable SiC heating element (DIL40200A84.000-00 and DIL40200A84.500-00)	1650°C	6.219.1-71.1.00
Fused Silica		1100°C	6.219.1-71.2.00
Al <sub>2</sub> O <sub>3</sub>	Graphite furnace (DIL40200A86.000-00)	1680°C	6.219.2-25.6.00 <sup>1</sup>
Glassy Carbon		2000°C	6.219.2-25.4.00 <sup>1</sup>
Glassy Carbon	2400°C furnace (DIL40200A87.000-00) and 2800°C furnace (DIL40200A88.000-00)	2800°C	DIL40200A88.020-00
Al <sub>2</sub> O <sub>3</sub>	2400°C furnace (DIL40200A87.000-00) and 2800°C furnace (DIL40200A88.000-00)	1680°C	DIL40200A88.021-00

<sup>1</sup> Inclusive radiation shield inset respectively insulating plug



Protective tube made of alumina (order no. 6.219.1-71.1.00)



Protective tube made of fused silica (order no. 6.219.1-71.2.00)

Accessories			
Element	Remarks	Order Number	
Pyrometer extension with mounting flange and furnace window		DIL40200A88.050-00	
Furnace window	Spare part for DIL40200A88.050-00	DIL40200A88.051-00	
Conversion kit 1680°C for the 2000°C furnace	Al <sub>2</sub> O <sub>3</sub> protective tube, O-ring seals and insulating part included	6.219.2-25.6.00	
Conversion kit 1680°C for the 2400/2800°C furnace	Al <sub>2</sub> O <sub>3</sub> protective tube, O-ring seals and radiation shield inset NGB817440 included	DIL40200A88.021-00	
Radiation shield inset made of alumina	Spare part for DIL40200A88.021-00	NGB817440	
Radiation shield inset made of graphite	Spare part for DIL40200A88.020-00	DIL40200A88.020-02	
Radiation shield inset made of graphite	Spare part for 6.219.2-25.4.00	GB800220	
Insulating plug of alumina	Spare part for 6.219.2-25.6.00	NGB821720	

# DIL 402 Expedis Accessories

## Sample Holders for Tension Measurements - Complete

Type	Material	Temp. (max.)	Remarks	Order Number
Sample holder kit	Al <sub>2</sub> O <sub>3</sub>	1600°C	With holding tube, tension rod, thermocouple type S, two clamps made of ground Al <sub>2</sub> O <sub>3</sub> ceramics with Al <sub>2</sub> O <sub>3</sub> screws and nuts, clamping jaws, upper part, with smooth surface for soft samples and with crimping edge for hard samples, alignment fixture for easy and precise sample preparation, and reference sample NGB811260 made of Al <sub>2</sub> O <sub>3</sub> for tension setup, max. sample length: 52 mm, width: 8 mm, thickness: 1 mm	DIL 40200A76.000-00

## Spare Parts of Sample Holder Set DIL40200A76.000-00

Type	Material	Temp. (max.)	Remarks	Order Number
Sample holder tube	Al <sub>2</sub> O <sub>3</sub>	1600°C	With holding tube, support plate and thermocouple holding segment	DIL 40200A76.010-00
Tension rod	Al <sub>2</sub> O <sub>3</sub>	1600°C	With support plate	DIL40200A60.020-00
Support plate	Al <sub>2</sub> O <sub>3</sub>	1600°C		NGB816814
Clamp	Al <sub>2</sub> O <sub>3</sub>	1600°C	Made of ground Al <sub>2</sub> O <sub>3</sub> ceramics with Al <sub>2</sub> O <sub>3</sub> screw and nut, max. sample width: 8 mm, thickness: 1 mm	TMA40200A06.022-00
Clamping jaws, lower part	Al <sub>2</sub> O <sub>3</sub>	1600°C		NGB810640
Clamping jaws, upper part	Al <sub>2</sub> O <sub>3</sub>	1600°C	With ground cutting edge, recommended for hard samples	NGB810639
Clamping jaws, upper part	Al <sub>2</sub> O <sub>3</sub>	1600°C	With smooth clamping surface, recommended for soft samples	NGB811264
Hexagon bolt	Al <sub>2</sub> O <sub>3</sub>	1600°C	With hex nut made of Al <sub>2</sub> O <sub>3</sub>	NGB810662
Clamp	Titanium	500°C	With titanium screw and nut, max. sample width: 8 mm, thickness: 1 mm;	TMA40200A06.028-00
Clamping jaws, lower part	Titanium	500°C		NGB813638
Clamping jaws, upper part	Titanium	500°C		NGB813637
Hexagon head screw M2x5 mm	Titanium	500°C		NGB815351
Hexagon nut M2	Titanium	500°C		NGB815352
Alignment fixture			For easy and precise preparation of tension samples, with adjustment tool for sample lengths 5; 10; 15; 20; 25; 40; 50 mm, for use with clamp TMA40200A06.022-00 and TMA40200A06.028-00	DIL40200A76.040-00



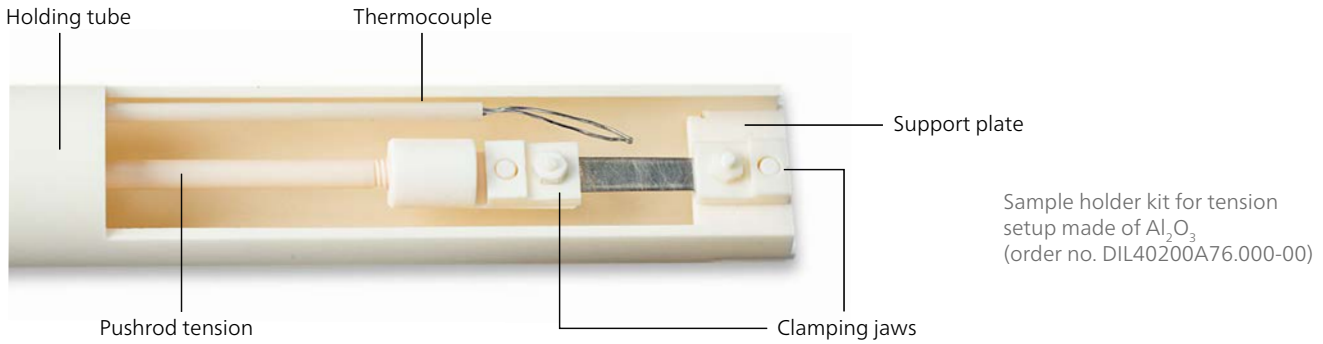

Upper parts of clamp with ground cutting edge (for hard samples) and smooth clamping surface (for soft samples)

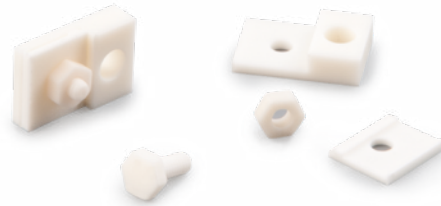

Clamping jaws with hexagonal bolt and nut (order no. TMA40200A06.022-00)

## Oxygen Trap System (OTS®)

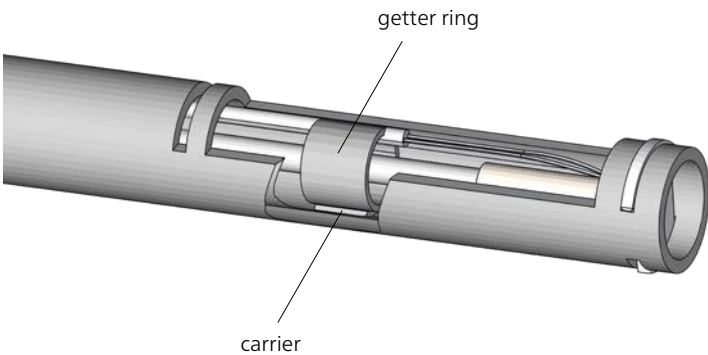

The presence of residual oxygen can be critical in certain applications (e.g., metals, metal alloys) because possible oxidation of the sample would lead to undesired results and false interpretations. The OTS® system allows for effective reduction of the oxygen partial pressure in the vicinity of the sample. A ceramic substrate bearing a getter ring is mounted on the sample carrier or in the sample carrier tube. The residual oxygen content remaining after evacuation is thereby almost entirely eliminated (< 1 ppm).

### OTS® Oxygen Trap System for Dilatometers

Description	Consists of	Sample holder	Order Number
OTS® system for removing traces of oxygen from purge gases such as argon or helium	3 getter rings with carriers	Ø 12 mm	6.219.1-63.1.00
OTS® system for removing traces of oxygen from purge gases such as argon or helium	3 getter rings with carriers	Ø 19 mm	DIL40200A63.010-00

## Sample Holders and Containers for Special Applications

### Sample Holders and Accessories for Foils and Thin Samples

Type	Material	Remarks	Order Number
Slotted rod for measurements on thin foils	Al <sub>2</sub> O <sub>3</sub>	Ø 6 × 4 mm, slot width: 0.3 mm	NGB809813
Slotted rod for measurements on thin foils	Al <sub>2</sub> O <sub>3</sub>	Ø 6 × 23 mm, slot width: 0.25 mm	NGB809785
Slotted rod for measurements on thin glasses and foils	Fused silica	Ø 8 × 20 mm, slot width: 0.8 mm	NGB803718
Slotted rod for measurements on thin foils	Fused silica	Ø 6 × 23 mm, slot width: 0.25 mm	NGB809786
Sample holder set for measurements on plane-parallel sample plates (12 x 4 x 1 mm) <sup>1</sup>	Al <sub>2</sub> O <sub>3</sub>	Consists of sample support, cap for the pushrod and Al <sub>2</sub> O <sub>3</sub> sample plate for calibration	6.219.1-61.1.00

<sup>1</sup> Only suitable for 12mm sample holder



Set for measurement on plane-parallel sample plates (order no. 6.219.1-61.1.00)



Slotted rods for measurement on foils (order no. NGB809813 and NGB809785)

### Sample Containers for Special Applications: Pastes, Powders, Liquids

Material	Sample Type	Consists of	Container Size	Temperature (max.)	Order Number
Al <sub>2</sub> O <sub>3</sub> <sup>1</sup>	Metal melts; pasty, powdery substances	Cylinder and 2 pistons	Ø 6.5 mm × 9 mm, 300 mm <sup>3</sup>	1500°C	6.219.1-60.1.00
Fused Silica	Pasty, powdery substances; high-viscosity liquids	Cylinder and 2 pistons	Ø 6.5 mm × 9 mm, 300 mm <sup>3</sup>	1000°C	6.219.1-60.2.00
Sapphire <sup>1</sup>	Metal melts; pasty, powdery substances	Cylinder and 2 pistons	Ø 6.5 mm × 9 mm, 300 mm <sup>3</sup>	1600°C	6.219.1-60.3.00
Graphite	Metal melts; pasty and powdery substances	Cylinder and 2 pistons	Ø 6.5 mm × 9 mm, 300 mm <sup>3</sup>	2000°C (inert atm.)	6.219.1-60.4.00
Steel	Waxes and liquids	Sample container, screwing and 10 seal diaphragms	Ø 6 mm × 15 mm, about 400 mm <sup>3</sup>	150°C	6.219.1-62.1.00

<sup>1</sup> Reaction may occur between Al<sub>2</sub>O<sub>3</sub>/sapphire and graphite at temperatures above 1400 °C



Sample containers made of alumina, fused silica, sapphire and graphite



Sample container for wax and liquid samples (order no. 6.219.1-62.1.00)

## Protective Sleeves and Spacers

To prevent the occurrence of chemical reactions between the sample and sample holder during the measurement, protective sleeves can be used. Spacers can be used to protect the pushrod from sticking to the sample.

### Protective Sleeves for Samples

Material	Temperature (max.)	Remarks	Order Number
Molybdenum	1900°C <sup>1</sup>	2 insertable cover disks included	6.214.5-90.4.00
BN	2200°C <sup>1</sup>	2 insertable cover disks included	6.214.5-90.5.00
AlN	1200°C <sup>1</sup>	2 insertable cover disks included	6.214.5-90.6.00
Graphite	2800°C <sup>1</sup>	2 insertable cover disks included	6.214.5-90.7.00

<sup>1</sup>in inert atmosphere

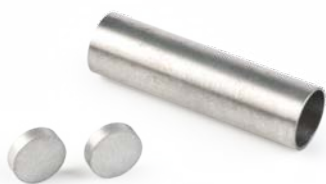

Protective sleeve made of molybdenum (order no. 6.214.5-90.4.00)



Protective sleeve made of AlN (order no. 6.214.5-90.6.00)



Protective sleeve made of graphite (order no. 6.214.5-90.7.00)

### Spacers

Material	Diameter	Thickness	Temperature (max.)	Order Number
Al <sub>2</sub> O <sub>3</sub>	6 mm	0.63 mm	1600°C	NGB805584
Al <sub>2</sub> O <sub>3</sub>	8 mm	0.63 mm	1600°C	NGB800322
Fused Silica	9 mm	1 mm	1100°C	NGB399313
Graphite	9 mm	0.5 mm	2000°C	NGB812737



Spacers made of alumina, fused silica and graphite

# DIL 402 E



DIL 402 E

The NETZSCH high-temperature models are our DIL 402 E/7 and DIL 402 E/8. These instruments are capable of carrying out measurements up to 2400°C and 2800°C, respectively. The standard sample thermocouple can be used for temperature measurements up to 2000°C, the devices can thus be equipped with a pyrometer for contactless temperature measurement.

## DIL 402 E – Pyrometer

Temperature (min.)	Temperature (max.)	For Dilatometer	Order Number
650°C	2400°C	DIL 402 E/7	6.214.8-93.0.00
650°C	2800°C	DIL 402 E/8	6.214.8-93.0.00

## DIL 402 E/7 – Sample Holder Kits Including Sample Support Tube and Mounting Flange

Material	Sample Length <sup>1</sup> (max.)	Sample Ø (max.)	Temperature (max.)	Thermocouple	Order Number
Graphite	25 mm	6 mm	2000°C (inert atm.)	Control and sample thermocouple Type D <sup>2</sup>	6.214.5-94.0.00+W
Graphite	25 mm	6 mm	2400°C (inert atm.)	Safety thermocouple Type D <sup>2</sup> for pyrometer measurement	6.214.5-95.0.00+W
Glassy carbon	25 mm	6 mm	2000°C (inert atm.)	Control and sample thermocouple Type D <sup>2</sup>	6.214.5-96.0.00+W
Glassy carbon	25 mm	6 mm	2400°C (inert atm.)	Safety thermocouple Type D <sup>2</sup> for pyrometer measurement	6.214.5-97.0.00+W
Al <sub>2</sub> O <sub>3</sub>	40 mm	12 mm	1680°C	Type S	6.214.5-98.0.00+S

<sup>1</sup> Minimum sample length depends on sample's expansion.

<sup>2</sup> W3%Re-W25%Re

### DIL 402 E/8 – Sample Holder Kits Including Sample Support Tube and Mounting Flange

Material	Sample Length <sup>1</sup>	Sample Ø	Temperature <sup>2</sup>	Thermocouple	Order Number
Graphite	15 mm max.	6 mm max.	2000°C	Control and sample thermocouple Type D <sup>3</sup>	6.214.8-94.0.00+W
Graphite	15 mm max.	6 mm max.	2800°C	Safety thermocouple Type D <sup>3</sup> for pyrometer measurement	6.214.8-96.0.00+W

<sup>1</sup> Minimum sample length depends on sample's expansion.

<sup>2</sup> Maximum temperature, inert atmosphere required

<sup>3</sup> W3%Re-W25%Re

### DIL 402 E/7 – Tube Sample Holders as Spare Parts, without Thermocouple and Pushrod

Material	Sample Length (max.)	Sample Ø (max.)	Temperature (max.)	Spare Part for Tube Sample Holder Kit	Order Number
Graphite	25 mm	6 mm	2400°C (inert atm.)	6.214.5-94.0.00+W, 6.214.5-95.0.00+W	6.214.5-40.1.00
Glassy carbon <sup>1</sup>	25 mm	6 mm	2400°C (inert atm.)	6.214.5-96.0.00+W, 6.214.5-97.0.00+W	6.214.5-44.1.00
Al <sub>2</sub> O <sub>3</sub>	40 mm	12 mm	1680°C	6.214.5-98.0.00+S	6.214.1-48.1.00

<sup>1</sup> Less wear than graphite due to lower vapor pressure

### DIL 402 E/8 – Tube Sample Holders as Spare Parts, without Thermocouple and Pushrod

Material	Sample Length (max.)	Sample Ø (max.)	Temperature (max.)	Spare Part for Tube Sample Holder Kit	Order Number
Graphite	15 mm	6 mm	2800°C (inert atm.)	6.214.8-94.0.00+W, 6.214.8-96.0.00+W	6.214.8-40.1.00



This graphite sample holder with thermocouple W/Re allows measurements up to 2000°C.

### DIL 402 E/7 – Pushrods

Material	Sample Length <sup>1</sup>	Temperature (max.)	Order Number
Graphite	0 mm to 25 mm	2400°C (inert atm.)	6.214.5-40.2.00
Al <sub>2</sub> O <sub>3</sub>	0 mm to 40 mm	1680°C	6.214.1-48.2.00
Al <sub>2</sub> O <sub>3</sub>	10 mm to 50 mm	1680°C	6.214.1-49.1.00
Glassy carbon <sup>2</sup>	0 mm to 25 mm	2400°C (inert atm.)	6.214.5-44.2.00

<sup>1</sup> Minimum sample length depends on sample's expansion.

<sup>2</sup> Less wear than graphite due to lower vapor pressure.

### DIL 402 E/8 – Pushrods

Material	Sample Length <sup>1</sup>	Temperature (max.)	Order Number
Graphite	0 mm to 15 mm	2800°C (inert atm.)	6.214.8-40.2.00

<sup>1</sup> Minimum sample length depends on sample's expansion.



Pushrods made of alumina, graphite and glassy carbon

### DIL 402 E/7 – Protective Sleeves for Samples

Material	Temperature (max.) in Inert Atmosphere	Remarks	Order Number
Molybdenum	1900°C	2 insertable cover disks included	6.214.5-90.4.00
BN	2200°C	2 insertable cover disks included	6.214.5-90.5.00
AlN	1200°C	2 insertable cover disks included	6.214.5-90.6.00
Graphite	2800°C	2 insertable cover disks included	6.214.5-90.7.00

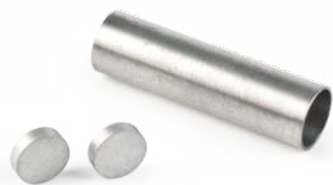

Protective sleeve made of molybdenum  
(order no. 6.214.5-90.4.00)



Protective sleeve made of AlN  
(order no. 6.214.5-90.6.00)



Protective sleeve made of graphite  
(order no. 6.214.5-90.7.00)

## DIL 402 E/7 and DIL 402 E/8 – Spacers

Material	Diameter	Thickness	Temperature (max.)	Order Number
Al <sub>2</sub> O <sub>3</sub>	8 mm	0.63 mm	1600°C	NGB800322
Graphite	9 mm	0.5 mm	2800°C	NGB812737



Spacers made of alumina and graphite

## DIL 402 E/7 – Sample Containers for Special Applications : Pastes, Powders, Liquids

Material	Sample Type	Consists of	Container Size	Temperature (max.)	Order Number
Al <sub>2</sub> O <sub>3</sub> <sup>1</sup>	Metal melts; pasty, powdery substances	Cylinder and 2 pistons	Ø 6.5 mm × 9 mm, 300 mm <sup>3</sup>	1600°C	6.219.1-60.1.00
Fused Silica	Pasty, powdery substances; high-viscosity liquids	Cylinder and 2 pistons	Ø 6.5 mm × 9 mm, 300 mm <sup>3</sup>	1000°C	6.219.1-60.2.00
Sapphire <sup>1</sup>	Metal melts; pasty, powdery substances	Cylinder and 2 pistons	Ø 6.5 mm × 9 mm, 300 mm <sup>3</sup>	1600°C	6.219.1-60.3.00
Graphite	Metal melts; pasty and powdery substances	Cylinder and 2 pistons	Ø 6.5 mm × 9 mm, 300 mm <sup>3</sup>	2000°C (inert atm.)	6.219.1-60.4.00

<sup>1</sup> Reaction may occur between Al<sub>2</sub>O<sub>3</sub>/sapphire and graphite at temperatures above 1400 °C



Sample containers made of alumina, fused silica and graphite

### DIL 402 E/7 – Sample and Safety Thermocouples

Type	Temperature (max.)	Remarks	Order Number
Safety thermocouple	2400°C	Type D <sup>1</sup>	6.214-5-41.1.00
Sample thermocouple	2000°C	Type D <sup>1</sup> , Mo-sheathed	6.214.5-91.4.00
Sample thermocouple	1680°C	Type S	6.214.1-48.3.00+S
Sample thermocouple	2000°C	Type D <sup>1</sup>	6.214.5-40.3.00+W

<sup>1</sup> W3%Re-W25%Re

### DIL 402 E/8 – Sample and Safety Thermocouples

Type	Temperature (max.)	Remarks	Order Number
Safety thermocouple	2800°C	Type D <sup>1</sup>	6.214-8-41.1.00
Sample thermocouple	2000°C	Type D <sup>1</sup>	6.214.8-40.3.00

<sup>1</sup> W3%Re-W25%Re



Sample thermocouple type S (order no. 6.214.1-48.3.00+S)

### DIL 402 E/7 and DIL 402 E/8 – Highest Temperature Tube Furnaces

Instrument Version	Temperature Range	Remarks	Order Number
DIL 402 E/7	RT to 2000°C (thermocouple operation) 650°C to 2400°C (pyrometer operation)	Furnace guide carriage 6.214.8-07.0.00 required. For operation under Ar (up to 2000°C) or He (up to 2400°C)	6.214.5-09.0.00
DIL 402 E/8	RT to 2000°C (thermocouple operation) 650°C to 2800°C (pyrometer operation)	For operation under He	6.214.8-08.0.00



### DIL 402 E/7 – Accessories for Furnace 6.214.5-09.0.00

Type	Remarks	Order Number
Furnace guide carriage	Required with furnace 6.214.5-09.0.00	6.214.8-07.0.00
Heating element made of graphite	Connections, insulation shells and set of O-rings included	6.214.5-90.2.00
Set of O-rings for furnace		6.214.5-90.3.00
Control thermocouple	Type D <sup>1</sup> , Mo-sheathed, max. temperature 2000°C	6.214.5-91.7.00

<sup>1</sup> W3%Re-W25%Re

### DIL 402 E/8 – Accessories for Furnace 6.214.8-08.0.00

Type	Remarks	Order Number
Furnace guide carriage	Required with furnace 6.214.8-08.0.00	6.214.8-07.0.00
Heating element made of graphite	Connections, insulation shells and set of O-rings included	6.214.8-90.2.00



Protective tube made of glassy carbon with O-rings (order no. 6.214.5-91.6.00)



Control thermocouple made of W/Re; molybdenum-sheathed (order no. 6.214.5-91.7.00)

### DIL 402 E/7 – Protective Tubes

Material	Temperature (max.)	Atmosphere	Remarks	Order Number
Glassy carbon	2000°C	Inert	Set of O-rings included	6.214.5-91.6.00
Al <sub>2</sub> O <sub>3</sub>	1680°C	Inert, oxidizing	Set of seals, insulating parts and gas plug connections included	6.214.5-90.1.00
Al <sub>2</sub> O <sub>3</sub>	1680°C	Inert, oxidizing	Set of O-rings included, spare part for 6.214.5-90.1.00	6.214.5-91.1.00

# TMA 402 *F1/F3* Hyperion®

A thermomechanical analyzer (TMA) measures the dimensional changes of a sample under a defined load as a function of temperature. For optimal adaptation of the system to your applications, the TMA 402 **F1** and **F3** Hyperion® instruments can each be used with different sample holders: you can choose from among expansion/penetration, 3-point bending and tension measurements. To cover a broad temperature range sample holders are available in fused silica (low temperature range) and in alumina (for high temperature range). Both instruments are vacuum-tight, guaranteeing a pure atmosphere around the sample during measurement.

The TMA 402 **F1** Hyperion® additionally allows measurements under a modulated load in order to investigate the viscoelastic properties of a material.

The *Polymer Edition* is a version of the TMA 402 **F3** Hyperion® that has been especially designed for the requirements of the polymer industry. It comprises a compact highly reactive furnace which is connected to a mechanical cooling device and covers a range from -70°C to 450°C without the need of LN<sub>2</sub>.



TMA 402 **F3** Hyperion®

## Measuring Modes and Fixture Sets

### Expansion/Penetration

Samples with different geometries (cylindrical, rectangular) are measured in the expansion mode. Sample fixtures with a small tip diameter ( $\varnothing$  1 mm) are also available for penetration measurements.



Fixture set for expansion/  
penetration made of alumina

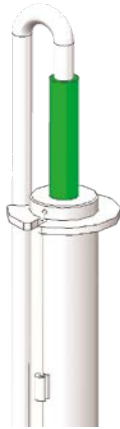

Fixture set for expansion  
made of fused silica

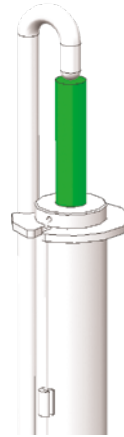

Fixture set for expansion  
made of fused silica,  
spherical type



Fixture set for penetration  
made of fused silica



Fixture set for dilatation  
made of fused silica



Fixture set for dilatation  
made of fused silica,  
spherical type



Fixture set for penetration  
made of fused silica

### 3-Point Bending

Fixture sets for 3-point bending geometry can be used in two different free bending lengths: 5 mm, 10 mm and 20 mm. This allows measurements on samples of different sizes without changing the sample holder.



Fixture set for 3-point bending made of alumina, bending length: 10 and 20 mm



Fixture set for 3-point bending made of fused silica, bending length: 10 and 20 mm



Fixture set for 3-point bending made of fused silica, bending length: 5, 10 and 20 mm



Fixture set for 3-point bending made of fused silica, bending length: 5 mm

### Tension

The tension mode is used to measure the expansion or shrinkage of a thin film or a fiber during a controlled temperature program.



Fixture set for tension made of alumina

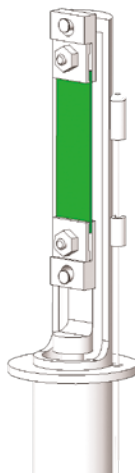

Fixture set for tension made of fused silica



Fixture set for tension made of fused silica

## Sample Fixture Sets Made of Alumina

Measurement Mode	Description	Temp. Range	Sample Dimensions (max.)	Remarks	Order Number
Expansion, penetration	Al <sub>2</sub> O <sub>3</sub> support tube with flange, Al <sub>2</sub> O <sub>3</sub> pushrod with socket and pushrod cap, 2 Al <sub>2</sub> O <sub>3</sub> support tube caps (flat tips, Ø 4mm and 1 mm).	RT to 1550°C	Ø: 10 mm Length: 30 mm	Standard material 6.219.1-92.2.00 made of highly polycrystalline Al <sub>2</sub> O <sub>3</sub> , Ø 6 mm x 25 mm included.	TMA40200A07.031-00
3-point bending	Al <sub>2</sub> O <sub>3</sub> pushrod cap, Al <sub>2</sub> O <sub>3</sub> support tube cap.	RT to 1550°C	Length: 24 mm Width: 5 mm	Bending distance 10 or 20 mm; Al <sub>2</sub> O <sub>3</sub> pushrod and Al <sub>2</sub> O <sub>3</sub> support tube from TMA40200A07.031-00 required; standard material NGB811259 made of Al <sub>2</sub> O <sub>3</sub> (24x5x4 mm) included.	TMA40200A07.032-00
Tension	Al <sub>2</sub> O <sub>3</sub> pushrod with socket, two Al <sub>2</sub> O <sub>3</sub> fixing bolts, two clamps made of ground Al <sub>2</sub> O <sub>3</sub> ceramics with Al <sub>2</sub> O <sub>3</sub> screws and nuts, alignment fixture for sample preparation.	RT to 1550°C	Length: 30 mm Width: 8 mm Thickness: 1 mm	Al <sub>2</sub> O <sub>3</sub> support tube from TMA40200A07.031-00 required; standard material NGB811260 made of Al <sub>2</sub> O <sub>3</sub> included.	TMA40200A07.033-00

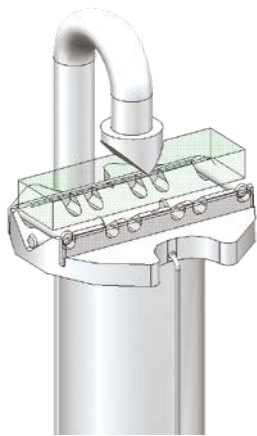

Detail fused silica 3-point bending sample holder (prism support), order no. TMA40200A06.050-00

In this geometry, the sample supports can tilt slightly, thus accommodating for e.g. slightly warped sample geometry. It is also beneficial for very hard samples, ensuring perfect line contacts across the whole sample width by self-alignment. The sample holder offers support distances 5, 10 and 20 mm.

## Sample Fixture Sets Made of Fused Silica

Measurement Mode	Description	Temp. Range	Sample Dimensions (max.)	Remarks	Order Number
Expansion, penetration	Fused silica support tube with flange, two fused silica pushrods (flat tips, Ø 4 mm and 1 mm) with sockets.	-150°C to 1000°C	Ø: 12 mm Length: 30 mm	Standard material 6.216.0-91.1.00 made of fused silica, Ø 6 mm x 25 mm included.	TMA40200A06.031-00
Expansion	Fused silica support tube with flange, fused silica pushrod (flat tip, Ø 4 mm) with socket.	-150°C to 1000°C	Ø: 12 mm Length: 30 mm	Standard material 6.216.0-91.1.00 made of fused silica, Ø 6 mm x 25 mm included.	TMA40200A06.035-00
Expansion	Fused silica support tube, (flat tip, Ø 4 mm), with flange, fused silica pushrod with socket.	-150°C to 1000°C	Ø: 8 mm Length: 30 mm	Standard material not included.	TMA40200B06.700-00
Expansion	Fused silica support tube, (spherical tip, Ø 4 mm), with flange, fused silica pushrod with socket.	-150°C to 1000°C	Ø: 8 mm Length: 30 mm	Standard material not included.	TMA40200B06.300-00
Penetration	Fused silica support tube, (flat tip, Ø 1 mm), with flange, fused silica pushrod with socket.	-150°C to 1000°C	Ø: 8 mm Length: 30 mm	Standard material not included.	TMA40200B06.200-00
3-point bending	Fused silica support tube with flange, fused silica pushrod (edge-shaped) with socket.	-150°C to 1000°C	Length: 24 mm Width: 5 mm	Bending distance 10 or 20 mm; standard material NGB81 1259 made of Al <sub>2</sub> O <sub>3</sub> (24x5x4 mm) for bending setup included.	TMA40200A06.032-00
3-point bending	Fused silica support tube with flange, fused silica pushrod (edge-shaped) with socket.	-150°C to 1000°C	Length: 24 mm Width: 5 mm	Bending distance 5, 10 or 20 mm; standard material NGB81 1259 made of Al <sub>2</sub> O <sub>3</sub> (24x5x4 mm) for bending setup included.	TMA40200A06.050-00
3-point bending	Fused silica support tube (edge-shaped), with flange, fused silica pushrod with socket.	-150°C to 1000°C	Length: 10 mm Width: 5 mm	Bending distance 5 mm; standard material not included.	TMA40200B06.500-00
Tension	Fused silica support tube with flange, fused silica pushrod with socket, two clamps made of ground alumina ceramics with alumina screws and nuts, alignment fixture for easy and precise sample preparation.	-150°C to 1000°C	Length: 30 mm Width: 8 mm Thickness: 1 mm	Standard material NGB81 1260 made of Al <sub>2</sub> O <sub>3</sub> for tension setup included.	TMA40200A06.033-00

Tension	Fused silica support tube with flange, fused silica pushrod with socket, two clamps made of titanium with titanium screws and nuts, alignment fixture for easy and precise sample preparation.	-150°C to 500°C	Length: 30 mm Width: 8 mm Thickness: 1 mm	Standard material NGB813640 made of titanium for tension setup included.	TMA40200A06.034-00
Tension	Fused silica support tube with flange, fused silica pushrod with socket, two clamps made of stainless steel with stainless steel screws, fixation spring for the lower clamp made of Inconel (-150° to 600°C), alignment fixture for easy and precise sample preparation.	-150°C to 1000°C	Length: 30 mm Width: 6 mm Thickness: 1 mm	Standard material NGB820992 made of fused silica for tension setup included.	TMA40200B06.600-00



Accessories for sample fixture sets

Any of the spare parts for the fixture sets mentioned can be ordered individually. The support tube made of alumina is universally applicable for any mode.

Support Tubes Including Flange					
Material	Measurement Type	Temperature Range	Sample Dimensions (max.)	Spare Part for	Order Number
Fused silica	Expansion, penetration	-150°C to 1000°C	Ø: 12 mm, L: 30 mm	TMA40200A06.031-00	TMA40200A05.011-00
Fused silica	Expansion, flat tip Ø 4 mm	-150°C to 1000°C	Ø: 8 mm, L: 30 mm	TMA40200B06.700-00	TMA40200B06.702-00
Fused silica	Expansion, spherical tip, Ø 4 mm	-150°C to 1000°C	Ø: 8 mm, L: 30 mm	TMA40200B06.300-00	TMA40200B06.302-00
Fused silica	Penetration, flat tip Ø 1 mm	-150°C to 1000°C	Ø: 8 mm, L: 30 mm	TMA40200B06.200-00	TMA40200B06.201-00
Fused silica	3-point bending	-150°C to 1000°C	24 x 5 mm	TMA40200A06.032-00	TMA40200A05.025-00
Fused silica	3-point bending	-150°C to 1000°C	24 x 5 mm	TMA40200A06.050-00	TMA40200A06.051-00
Fused silica	3-point bending	-150°C to 1000°C	10 x 5 mm	TMA40200B06.500-00	TMA40200B06.502-00
Fused silica	Tension	-150°C to 1000°C	30 x 8 x 1 mm	TMA40200A06.033-00	TMA40200A06.011-00
Fused silica	Tension	-150°C to 1000°C	30 x 6 x 1 mm	TMA40200B06.600-00	TMA40200B06.602-00
Alumina	Expansion, penetration	RT to 1550°C	Ø: 10 mm, L: 30 mm	TMA40200A07.031-00	TMA40200A07.011-00
Alumina	3-point bending	RT to 1550°C	24 x 5 mm	TMA40200A07.032-00	TMA40200A07.011-00
Alumina	Tension	RT to 1550°C	30 x 8 x 1 mm	TTMA40200A07.033-00	TMA40200A07.011-00
Alumina	Expansion, penetration for water-vapour furnace	RT to 1250°C	Ø: 10 mm, L: 30 mm	TMA40200A88.030-00	TMA40200A88.031-00
Alumina	3-point bending for water-vapour furnace	RT to 1250°C	24 x 5 mm	TMA40200A07.032-00	TMA40200A88.031-00
Alumina	Tension for water-vapour furnace	RT to 1250°C	30 x 8 x 1 mm	TMA40200A88.040-00	TMA40200A88.031-00





Fused silica support tube for expansion/penetration (order no. TMA 40200A05.011-00)



Fused silica support tube for 3-point bending (order no. TMA 40200A05.025-00)



Fused silica support tube for tension (order no. TMA 40200A06.011-00)



Alumina support tube (order no. TMA 40200A07.011-00)

#### Support tubes including flange with fixed inset<sup>1</sup>

Material	Measurement Type	Temperature Range	Sample Dimensions (max.)	Spare Part for	Order Number
Alumina	Expansion, flat tip ø 4 mm	RT to 1550°C	ø: 10 mm,L: 30 mm	-	TMA40200A07.014-00
Alumina	Penetration, flat tip ø 1 mm	RT to 1550°C	ø: 10 mm. L: 30 mm	-	TMA40200A07.015-00
Alumina	3-point bending	RT to 1550°C	24 x 5 mm	-	TMA40200A07.016-00

<sup>1</sup> When using small forces in the range of its own weight, the insert is permanently fixed to the support tube for those parts.

## Compatibility Matrix for Sample Holders with Furnaces

Sample Holder	Furnace				
	B81 IC	A82 Steel	A84 SiC	A88 Water Vapor	A88.200 Copper
<b>Al<sub>2</sub>O<sub>3</sub></b>					
TMA40200A07.031-00	-	✓	✓	-	✓
TMA40200A07.032-00	-	✓	✓	✓	✓
TMA40200A07.033-00	-	✓	✓	-	✓
TMA40200A88.030-00	-	-	-	✓	-
TMA40200A88.040-00	-	-	-	✓	-
<b>Fused Silica</b>					
TMA40200A06.031-00	-	✓	✓	-	✓
TMA40200A06.032-00	-	✓	✓	-	✓
TMA40200A06.033-00	-	✓	✓	-	✓
TMA40200A06.034-00	-	✓	✓	-	✓
TMA40200A06.035-00	-	✓	✓	-	✓
TMA40200A06.050-00	-	✓	✓	-	✓
TMA40200B06.200-00	✓	✓	✓	-	✓
TMA40200B06.300-00	✓	✓	✓	-	✓
TMA40200B06.500-00	✓	✓	✓	-	✓
TMA40200B06.600-00	✓	✓	✓	-	✓
TMA40200B06.700-00	✓	✓	✓	-	✓

✓ suitable  
- unsuitable

Spacers can be used with the expansion/penetration sample holders to keep the pushrod from becoming contaminated. They can also be used to distribute forces evenly across the surface of large samples, thus preventing unwanted penetration.

### Spacers

Material	Diameter	Thickness	Temperature (max.)	Order Number
Al <sub>2</sub> O <sub>3</sub>	6 mm	0.63 mm	1600°C	NGB805584
Al <sub>2</sub> O <sub>3</sub>	8 mm	0.63 mm	1600°C	NGB800322
Fused silica	9 mm	1 mm	1100°C	GB399313



Spacers made of alumina and fused silica to prevent the sample from sticking to the pushrod

### Alumina Support Tube Caps for Alumina Sample Holders

Measurement Type	Temperature Range	Sample Dimensions (max.)	Spare Part for	Remarks	Order Number
Expansion	RT to 1550°C	Ø: 10 mm, L: 30 mm	TMA40200A07.031-00	Flat tip Ø 4 mm	NGB810605
Penetration	RT to 1550°C	Ø: 10 mm, L: 30 mm	TMA40200A07.031-00	Flat tip Ø 1 mm	NGB810618
Penetration (for special applications which require a ball-shaped tip)	RT to 1550°C	Ø: 10 mm, L: 30 mm	TMA40200A07.031-00 (additional part; not included by default)	Hemispherical tip Ø 4 mm	NGB821506 (must be ordered separately)
3-point bending	RT to 1550°C	24 x 5 mm	TMA40200A07.032-00		NGB810614

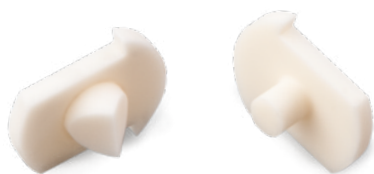

Alumina support caps for 3-point bending (left, order no. NGB810614) and expansion (right, order no. NGB810605)



Alumina support caps for penetration (left, order no. NGB810618) and for special penetration applications which require a ball-shaped tip (right, order no. NGB821506)

The alumina pushrod for expansion/penetration is similar to the one for 3-point bending; these can each be used with an appropriate cap.

Pushrods Including Socket, Pushrod Cap and Orifice Ring					
Material	Measurement Type	Temperature Range	Sample Dimensions (max.)	Spare Part for	Order Number
Fused silica	Expansion	-150°C to 1000°C	Ø: 12 mm, L: 30 mm	TMA40200A06.031-00	TMA40200A05.021-00
Fused silica	Expansion, flat tip Ø 4 mm	-150°C to 1000°C	Ø: 8 mm, L: 30 mm	TMA40200B06.700-00	TMA40200B06.701-00
Fused silica	Expansion, spherical tip, Ø 4 mm	-150°C to 1000°C	Ø: 8 mm, L: 30 mm	TMA40200B06.300-00	TMA40200B06.701-00
Fused silica	Penetration, flat tip Ø 1 mm	-150°C to 1000°C	Ø: 8 mm, L: 30 mm	TMA40200B06.200-00	TMA40200B06.701-00
Fused silica	Penetration, flat type Ø 1 mm	-150°C to 1000°C	Ø: 12 mm, L: 30 mm	TMA40200A06.031-00	TMA40200A05.022-00
Fused silica	3-point bending	-150°C to 1000°C	24 x 5 mm	TMA40200A06.050-00	TMA40200A05.024-00
Fused silica	3-point bending	-150°C to 1000°C	10 x 5 mm	TMA40200B06.500-00	TMA40200B06.501-00
Fused silica	Expansion, spherical type Ø 4 mm	-150°C to 1000°C	Ø: 12 mm, L: 30 mm	-	TMA40200A05.023-00
Fused silica	Tension	-150°C to 1000°C	30 x 6 x 1 mm	TMA40200B06.600-00	TMA40200B06.601-00
Fused silica	Penetration, flat type Ø 0.5 mm	-150°C to 1000°C	Ø: 12 mm, L: 30 mm	-	TMA40200A05.026-00
Fused silica	3-point bending	-150°C to 1000°C	24 x 5 mm	TMA40200A06.032-00	TMA40200A05.024-00
Fused silica	Tension	-150°C to 1000°C	30 x 8 x 1 mm	TMA40200A06.033-00	TMA40200A06.021-00
Alumina	Expansion, penetration	RT to 1550°C	Ø: 10 mm, L: 30 mm	TMA40200A07.031-00, TMA40200A07.032-00, TMA40200A88.030-00	TMA40200A07.021-00
Alumina	Tension	RT to 1550°C	30 x 8 x 1 mm	TMA40200A07.033-00	TMA40200A07.022-00
Alumina	Tension	RT to 1250°C	30 x 8 x 1 mm	TMA40200A88.040-00	TMA40200A88.041-00



Fused silica pushrod for tension (order no. TMA40200A06.021-00)

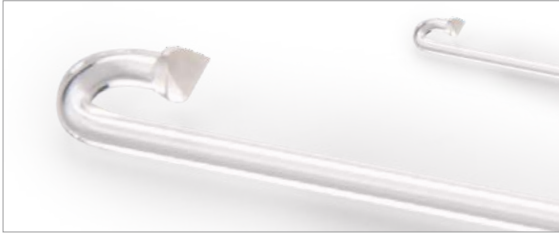

Fused silica pushrod for 3-point bending (order no. TMA40200A05.024-00)



Fused silica pushrod for expansion, spherical type (order no. TMA40200A05.023)



Fused silica pushrods for expansion (order no. TMA40200A05.021-00, lower) and penetration (order no. TMA40200A05.022-00, upper)



Alumina pushrod with pushrod cap for expansion/penetration (order no. TMA40200A07.021-00)



Alumina pushrod with pushrod cap for tension (order no. TMA40200A07.022-00)



Alumina pushrod with pushrod cap for tension for water vapour furnace (TMA40200A88.041-00)

### Universal Pushrod Including Socket, without Pushrod Cap and Orifice Ring

Material	Measurement Type	Temperature Range	Sample Dimensions (max.)	Spare Part for	Order Number
Alumina	Expansion, penetration, 3-point bending	RT to 1550°C	Ø 10 mm, L 30 mm	TMA40200A07.021-00, TMA40200A07.031-00	TMA40200A07.021-05



Universal Alumina Pushrod (order no. TMA40200A07.21-05)

### Pushrod Caps for Universal Alumina Pushrod

Measurement Type	Temperature Range	Sample Dimensions (max.)	Spare Part for	Order Number
Expansion, penetration	RT to 1550°C	Ø 10 mm, L 30 mm	TMA40200A07.031-00	NGB810612
Expansion, penetration	RT to 1550°C	Ø 10 mm x Ø 9 mm x 6 mm	TMA40200A07.031-00	NGB811215
Expansion, penetration	RT to 1550°C	Ø:11 mm, L: 30 mm	-	NGB821399
3-point bending <sup>1</sup>	RT to 1550°C	24 x 5 mm	TMA40200A07.032-00	NGB810615

<sup>1</sup> Bending supports can accommodate intervals of either 10 or 20 mm.

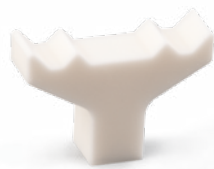

Pushrod cap for 3-point bending (order no. NGB810615)



Pushrod cap (order no. NGB821399) for sample diameters up to 11mm



Protection tube (order no. NGB811215) and pushrod cap (order no. NGB810612) for expansion/penetration

## Sample Thermocouples

Part	Temperature Range	Diameter	Remarks	Order Number
Type S, platinum- sheathed	RT to 1550°C	1 mm	Feedthrough socket and O-ring included (ready for installation); not recommended for reducing atmosphere	TMA40200A08.012-00
Type K, Inconel- sheathed	-150°C to 1000°C	0.5 mm	Feedthrough socket and O-ring included (ready for installation)	TMA40200A08.011-00

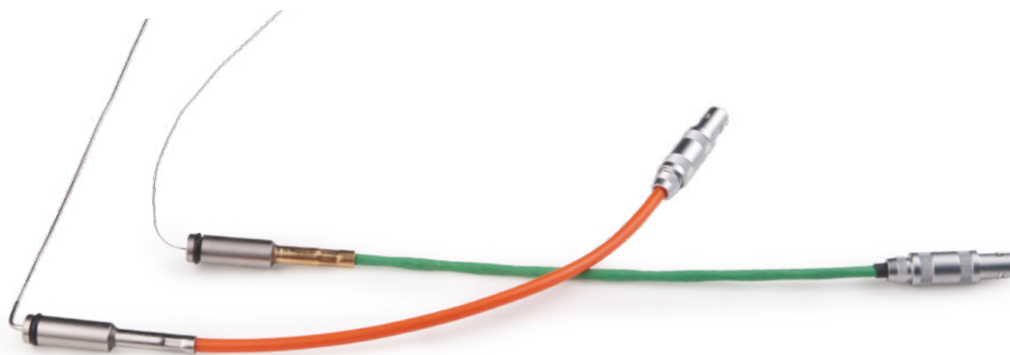

The type K thermocouple (green) can be used in any atmosphere (inert, oxidative or reducing).  
The type S thermocouple (red) is recommended for inert and oxidative gases. Please note: Reducing atmospheres might damage thermocouple type S.

Alumina clamps delivered with tension fixture sets have a ground cutting edge. They can be switched to clamps with a smooth clamping surface. Guide rings ensure good homogeneity of temperature by preventing convection.

Clamps			
Part	Temp. Range	Remarks	Order Number
Clamp	RT to 1550°C	Made of ground Al <sub>2</sub> O <sub>3</sub> ceramics with Al <sub>2</sub> O <sub>3</sub> screw and nut, max. sample width: 8 mm, thickness: 1 mm; Spare part for TMA40200A07.033-00, TMA40200A06.033-00	TMA40200A06.022-00
Clamping jaws, lower part	RT to 1550°C	Made of Al <sub>2</sub> O <sub>3</sub> ; Spare part for TMA40200A06.022-00	NGB810640
Clamping jaws, upper part	RT to 1550°C	Made of Al <sub>2</sub> O <sub>3</sub> ; With ground cutting edge, recommended for hard samples; Spare part for TMA40200A06.022-00	NGB810639
Clamping jaws, upper part	RT to 1550°C	Made of Al <sub>2</sub> O <sub>3</sub> , With smooth clamping surface, recommended for soft samples; Spare part for TMA40200A06.022-00	NGB811264
Hexagon bolt M 2x5 mm	RT to 1550°C	With hex nut made of Al <sub>2</sub> O <sub>3</sub> ; Spare part for TMA40200A06.022-00	NGB810662
Clamp	-150°C to 500°C	Made of titanium with titanium screw and nut, max. sample width: 8 mm, thickness: 1 mm; Spare part for TMA40200A06.034-00	TMA40200A06.028-00
Clamping jaws, upper part	-150°C to 500°C	Made of titanium; Spare part for TMA40200A06.028-00	NGB813638
Clamping jaws, lower part	-150°C to 500°C	Made of titanium; Spare part for TMA40200A06.028-00	NGB813637
Hexagon head screw M2x5 mm	-150°C to 500°C	Made of titanium; Spare part for TMA40200A06.028-00	NGB815351
Hexagon nut M2	-150°C to 500°C	Made of titanium; Spare part for TMA40200A06.028-00	NGB815352
Clamp	-150°C to 1000°C	Clamp made from stainless steel 1.4841, with screw from stainless steel 1.4841, maximum sample width 6 mm, maximum sample thickness 1 mm Spare part for TMA40200B06.600-00	TMA40200B06.605-00
Clamping jaws, lower part	-150°C to 1000°C	Clamping jaws, lower part, from stainless steel 1.4841 Spare part for TMA40200B06.605-00	NGB821349
Clamping jaws, upper part	-150°C to 1000°C	Clamping jaws, upper part, from stainless steel 1.4841 Spare part for TMA40200B06.605-00	NGB821350
Hexagon bolt M 2x5 mm	-150°C to 1000°C	Hexagon head screw M2x5mm, stainless steel 1.4841 Spare part for TMA40200B06.605-00	NGB821362
Torque screw-driver with accessories	-	For M2 screws with wrench size 4mm, adjustable within 0.02 ... 0.0.15 Nm	TMA40200A06.023-10



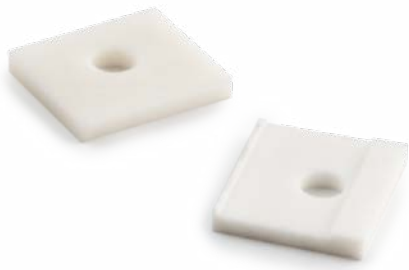

Upper parts of clamp with ground cutting edge (for hard samples) and smooth clamping surface (for soft samples)

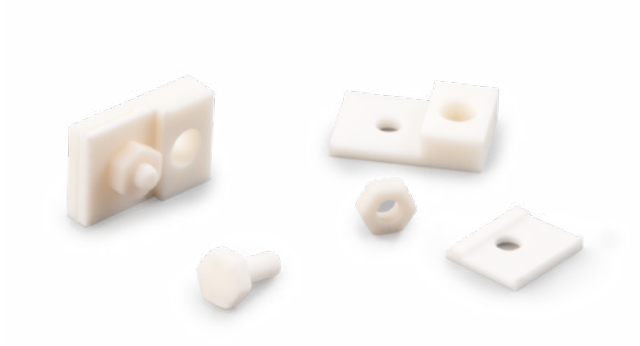

Clamping jaws with hexagonal bolt and nut (order no. TMA40200A06.022-00)



Clamping jaws made of titanium (order no. TMA40200A06.028-00)



Torque screwdriver with accessories for M2 screws (order no. TMA40200A06.023-10)

## Accessories

Part	Temp. Range	Remarks	Order Number
Alignment fixture		For easy and precise preparation of tension samples. Spare part for TMA40200A07.033-00, TMA40200A06.033-00; For use with clamp TMA40200A06.022-00; Adjustment tool for sample lengths 5, 10, 15 and 20 mm included	TMA40200A06.023-00
Low-temperature guide ring	-150°C to 1000°C	Recommended with sample fixture set TMA40200A06.031-00 (expansion/penetration) if LN <sub>2</sub> used as cooling agent	TMA40200A06.024-00
Low-temperature guide ring	-150°C to 1000°C	Recommended with sample fixture set TMA40200A06.033.00 (tension) if LN <sub>2</sub> used as cooling agent	TMA40200A06.025-00
Low-temperature guide ring	-150°C to 1000°C	Recommended with sample fixture set TMA40200A06.032.00 (3-point bending) if LN <sub>2</sub> used as cooling agent	TMA40200A06.026-00
Alignment fixture		Alignment fixture for easy and precise preparation of tension samples, with adjustment tool for sample lengths 5, 10 and 20 mm, for use with clamp TMA40200B06.605-00 Spare part for TMA40200B06.600-00	TMA40200B06.410-00
Inset		Inset for sample length 20 mm Spare part for TMA40200B06.410-00	NGB821054
Inset		Inset for sample length 10 mm Spare part for TMA40200B06.410-00	NGB821055
Inset		Inset for sample length 5 mm Spare part for TMA40200B06.410-00	NGB821056
Clip for fixation		Clip for fixation of the sample thermocouple to fused silica support, tubes with ø 14 mm Spare part for TMA40200B06.201-00, TMA40200B06.302-00, TMA40200B06.602-00 and TMA40200B06.702-00	NGB820915
Spring for fixation	-150°C to 600°C	Fixation spring, Inconel (2.4669), Spare part for TMA40200B06.600-00	NGB821348
Lateral Support	-150°C to 1000°C	Lateral support for TMA bending sample holder, made from fused silica, 0.5 x 2.4 x 21.5 mm Spare part for TMA40200A06.050-00	NGB820150
Support rod	-150°C to 1000°C	Support rod for TMA bending sample holder, made from fused silica, ø 1.5 x 8 mm Spare part for TMA40200A06.050-00	NGB820151

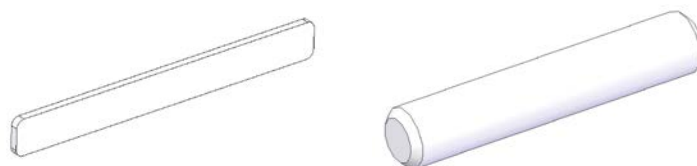

Lateral support (order no. NGB 820150) and support rod (order no. NGB 820151) for TMA bending sample holder



Alignment fixture for preparation of tension samples  
(order no. TMA40200B06.410-00)



Alignment fixture for preparation of tension samples  
(order no. TMA40200A06.023-00)

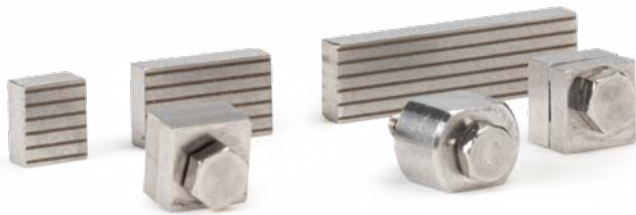

Insets for sample length (order numbers:  
NGB821054, NGB821055 and NGB821056)  
Clamps made from stainless steel 1.4841  
(order number: TMA40200B06.605-00)

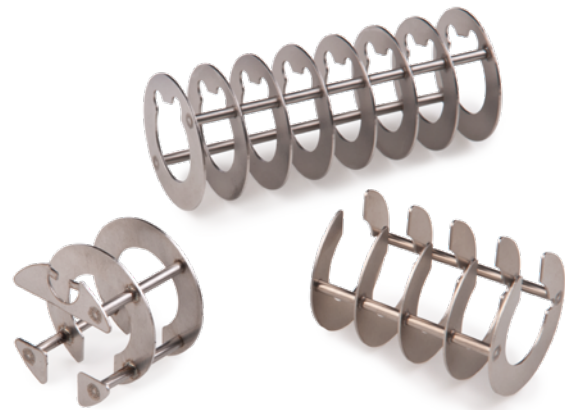

Low-temperature guide rings

Measurements on melts, pastes and powders can be carried out using sample containers specially developed for these applications.

Sample Containers for Special Applications						
Description	Material	Consists of	Container Dimensions	Temperature (max. <sup>1</sup> )	Remarks	Order Number
Container for pasty and powdery substances	Al <sub>2</sub> O <sub>3</sub>	Cylinder, 2 pistons	Ø: 6.5 mm Length: 9 mm Volume: 300 mm <sup>3</sup>	1550°C	Carrier disk NGB811319 required	6.219.1-60.1.00
Carrier disk	Al <sub>2</sub> O <sub>3</sub>			1550°C		NGB811319
Container for pasty and powdery substances	Fused silica	Cylinder, 2 pistons	Ø: 6.5 mm Length: 9 mm Volume: 300 mm <sup>3</sup>	1100°C	Carrier disk NGB811318 required	6.219.1-60.2.00
Carrier disk	Fused silica			1100°C		NGB811318
Container for metal melts and pasty or powdery substances	Sapphire	Cylinder, 2 pistons	Ø: 6.5 mm Length: 9 mm Volume: 300 mm <sup>3</sup>	1550°C	Carrier disk NGB811320 required	6.219.1-60.3.00
Carrier disk	Sapphire			1550°C		NGB811320
Container for pasty and powdery substances	Graphite	Cylinder, 2 pistons	Ø: 6.5 mm Length: 9 mm Volume: 300 mm <sup>3</sup>	1550°C	Carrier disk NGB814969 required; inert atmosphere required <sup>2</sup>	6.219.1-60.4.00
Carrier disk	Graphite			1550°C		NGB814969
Container for wax and liquids		Container, screwing, 10 seal diaphragms	Ø: 6.0 mm Length: 15 mm Volume: 400 mm <sup>3</sup>	150°C		6.219.1-62.1.00
Set of crucibles for sample immersion	Fused silica	3 crucibles (Ø: 14 mm, height: 8, 15, 30 mm), 2 spacers (Ø 9 mm, thickness 1 mm)		1100°C	TMA40200A06.031-00 required	TMA40200A06.027-00
Sample crucible for measurements on powders	Al <sub>2</sub> O <sub>3</sub>		outer bottom Ø: 6.8 mm; Volume: 85 µL	1550°C		GB399972
Spacer	Al <sub>2</sub> O <sub>3</sub>		Ø: 5.2 mm thickness: 0.63 mm	1550°C	Suited as insert for crucible GB399972	NGB815279

<sup>1</sup> Maximum temperature limited by maximum furnace temperature.

<sup>2</sup> Reaction may occur between Al<sub>2</sub>O<sub>3</sub>/sapphire and graphite at temperatures above 1400°C.

## Density Change of a Brass Sample during Heating

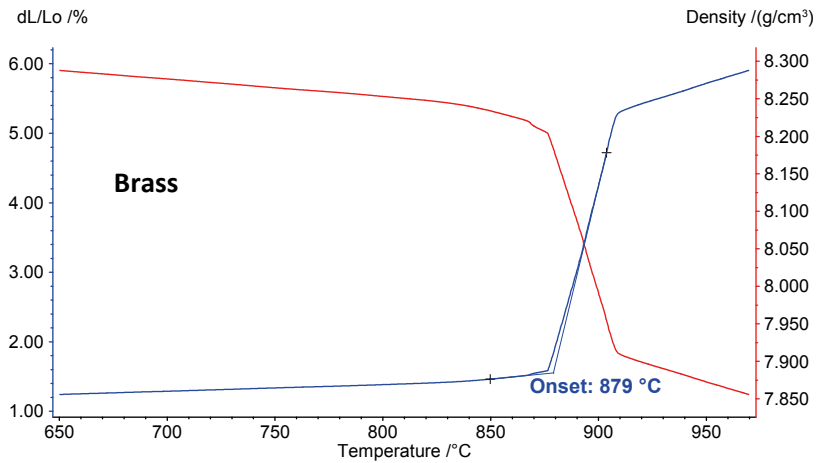

In this example, a brass sample was heated in an alumina container between room temperature and 970°C at 5 K/min with the TMA 402 **F1 Hyperion**® in a helium atmosphere. The density was determined at room temperature (8.3 g/cm<sup>3</sup>) and its change as a function of temperature was calculated based on measured dL-changes during heating. As can be seen in the plot on the left, the sample begins to melt at 879°C. This corresponds to an abrupt decrease in density.



Sample containers made of alumina (left), fused silica (middle), sapphire and graphite (right)



Sample container for measurements on wax (order no. 6.219.1-62.1.00)



Carrier disks for use with sample containers

## Determination of the Viscoelastic Properties of a Lycra Fiber in Tension Mode

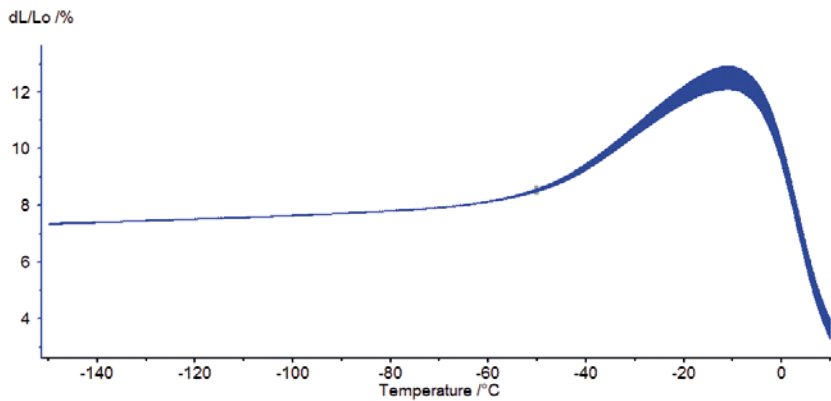

Length change of Lycra fiber during heating with modulation (tension mode)

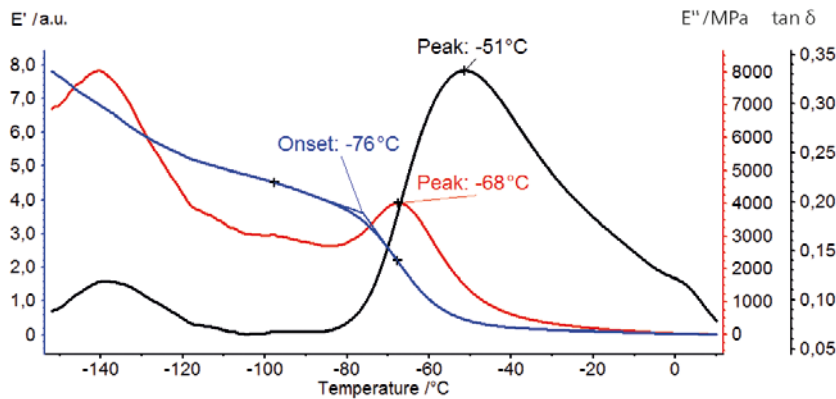

Viscoelastic properties of Lycra fiber measured in the TMA 402 **F1 Hyperion**<sup>®</sup>

The NETZSCH TMA 402 **F1 Hyperion**<sup>®</sup> even allows for modulated measurements with a frequency of up to 1 Hz. Such measurements produce better information about a material's viscoelastic properties.

In this example, a polyurethane fiber with an initial length of 10.30 mm was measured between -150°C and 10°C at 3 K/min in the fused silica tension sample holder. During heating, a sinusoidal force of 0.002 N with a frequency of 1 Hz was applied in addition to a static force of 0.01 N.

The length change during heating is depicted in figure 1. Figure 2 shows the viscoelastic properties of the fiber. Because of the undefined sample geometry, it was not possible to calculate the absolute values for the storage modulus, loss modulus and  $\tan\delta$ . That is why these curves are depicted in arbitrary units. The storage modulus (blue curve) decreases with increasing temperature. The sharp decrease at -76°C (onset temperature) indicates a glass transition. It is correlated with a peak at -68°C in the loss modulus curve (red curve) and at -51°C in the loss factor  $\tan\delta$  curve (black curve).

Tension sample holder made of fused silica



# Calibration Materials

Length change calibration is a very important factor in obtaining precise, absolute results from a dilatometer or TMA measurement. In order to achieve precise temperature values, dilatometers and TMAs should be temperature-calibrated. Temperature calibration of dilatometers is carried out using the *c-DTA*<sup>®</sup> signal or onset method. Calibration kits are available in a variety of formats, depending on the working temperature range.

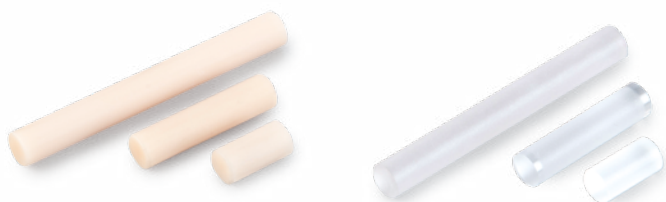

Standard calibration materials made of alumina and sapphire

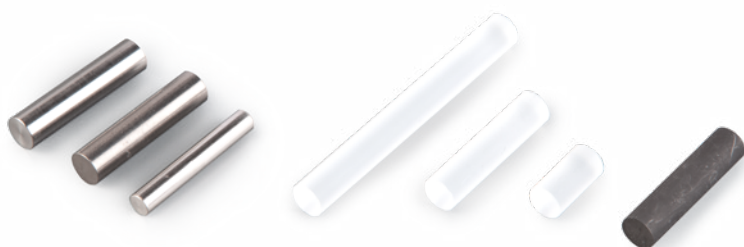

Standard calibration materials made of tungsten, platinum, fused silica and POCO graphite

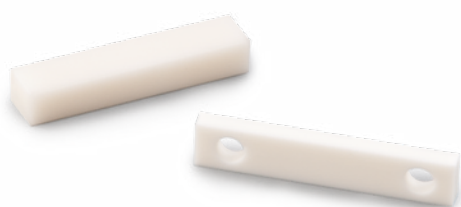

Standard calibration materials for TMA made of alumina for bending and tension (calibration standard for tension mode also suitable for dilatometer tests)

DIL 402 Expedis Classic

DIL 402 Expedis Select

DIL 402 Expedis Supreme (HT)

DIL 402 E

TMA 402 F1/F3 Hyperion<sup>®</sup>

### Calibration Materials with Expansion Table and Purity Certificate

Material	Temperature (max.)	Dimensions		Remarks	Order Number
		Diameter	Length		
Fused silica	1100°C	6 mm	50 mm	Expansion table and purity certificate included	6.214.1-91.1.00
Fused silica	1100°C	6 mm	25 mm	Expansion table and purity certificate included	6.216.0-91.1.00
Fused silica	1100°C	6 mm	20 mm	Expansion table and purity certificate included	6.217.1-91.1.00
Fused silica	1100°C	6 mm	12 mm	Expansion table and purity certificate included	6.219.1-92.8.00
Fused silica	1100°C	6 mm	10 mm	Expansion table and purity certificate included	6.219.1-92.16.00
Al <sub>2</sub> O <sub>3</sub> <sup>1</sup>	1680°C	6 mm	50 mm	High-purity, polycrystalline, Manufacturer's certificate included	6.219.1-92.5.00
Al <sub>2</sub> O <sub>3</sub> <sup>1</sup>	1680°C	6 mm	25 mm	High-purity, polycrystalline, Manufacturer's certificate included	6.219.1-92.2.00
Al <sub>2</sub> O <sub>3</sub> <sup>1</sup>	1680°C	6 mm	20 mm	High-purity, polycrystalline, Manufacturer's certificate included	6.217.1-91.2.00
Al <sub>2</sub> O <sub>3</sub> <sup>1</sup>	1680°C	6 mm	15 mm	High-purity, polycrystalline, Manufacturer's certificate included	6.219.1-92.11.00
Al <sub>2</sub> O <sub>3</sub> <sup>1</sup>	1680°C	6 mm	12 mm	High-purity, polycrystalline, Manufacturer's certificate included	6.219.1-92.7.00
Al <sub>2</sub> O <sub>3</sub> <sup>1</sup>	1680°C	6 mm	10 mm	High-purity, polycrystalline, Manufacturer's certificate included	6.219.1-92.10.00
Al <sub>2</sub> O <sub>3</sub> <sup>1</sup>	1680°C	6 mm	5 mm	High-purity, polycrystalline, Manufacturer's certificate included	6.219.1-92.14.00
Sapphire <sup>1</sup>	1680°C	6 mm	50 mm	Manufacturer's certificate included	6.219.1-92.6.00
Sapphire <sup>1</sup>	1680°C	6 mm	25 mm	Manufacturer's certificate included	6.219.1-92.3.00
Sapphire <sup>1</sup>	1680°C	6 mm	20 mm	Manufacturer's certificate included	6.217.1-91.3.00
Sapphire <sup>1</sup>	1680°C	6 mm	12 mm	Manufacturer's certificate included	6.219.1-92.9.00
Platinum	1000°C	4 mm	25 mm	Expansion table included	6.216.0-91.8.00
POCO graphite	2800°C	6 mm	25 mm	Expansion table included	6.216.0-91.7.00
Tungsten	2400°C	6 mm	25 mm	Expansion table included	6.216.0-91.6
Al <sub>2</sub> O <sub>3</sub>	1600°C	26 x 5 x 2 mm		For tension setup (used as reference for automatic detection of sample); for stiffness correction when non-static forces are applied	NGB811260
Al <sub>2</sub> O <sub>3</sub>	1600°C	24 x 5 x 4 mm		For bending setup; for stiffness correction when non-static forces are applied	NGB811259
Titanium	500°C	26 x 5 x 2 mm		For tension setup (used as reference for automatic detection of sample); for stiffness correction when non-static forces are applied	NGB813640

<sup>1</sup> Reaction may occur between Al<sub>2</sub>O<sub>3</sub>/sapphire and graphite at temperatures above 1400°C.



## Accessories for Temperature Calibration of Dilatometers with c-DTA®

Material	Remarks	Order Number
Crucible support and crucible	Made of Al <sub>2</sub> O <sub>3</sub> (Ø 6 × 25 mm) for -50°C to 1500°C <sup>1</sup> ; DTA calibration kit 6.223.5-91.3.00 or 6.223.5-91.1.00 and SW-CDTA-70x.1B (DIL 402 <i>Expedis</i> ) or SW-CDTA-69x.1B (DIL 402 E) required	6.219.1-93.1.00
Crucible support and crucible	Made of Al <sub>2</sub> O <sub>3</sub> (Ø 6 × 50 mm) for -50°C to 1500°C <sup>1</sup> ; DTA calibration kit 6.223.5-91.3.00 or 6.223.5-91.1.00 and SW-CDTA-70x.1B (DIL 402 <i>Expedis</i> ) or SW-CDTA-69x.1B (DIL 402 E) required	6.219.1-93.2.00
DSC/DTA calibration kit	Kit for 25°C to 1500°C incl. 8 samples: In, Sn, Zn, Bi, Al, Ag, Au, Ni; with manufacturer's certificate and detailed calibration instructions; for use in Al <sub>2</sub> O <sub>3</sub> crucible	6.223.5-91.3.30
DSC/DTA calibration kit	Kit for -70°C to 750°C incl. 7 samples: adamantane, In, Sn, Zn, Bi, CsCl, Al; with manufacturer's certificate and detailed calibration instructions; for use in Al <sub>2</sub> O <sub>3</sub> crucible	6.223.5-91.1.30
Adamantane	400 mg, spare part for 6.223.5-91.1.30	6.217.1-92.1.09
Indium	Foil Ø 0.25 mm, 99.999%, spare part for 6.223.5-91.1.30, 6.223.5-91.3.30	6.223.5-91.3.01
Tin	Foil Ø 0.25 mm, 99.99%, spare part for 6.223.5-91.1.30, 6.223.5-91.3.30	6.223.5-91.3.02
Zinc	Foil Ø 0.25 mm, 99.999%, spare part for 6.223.5-91.1.30, 6.223.5-91.3.30	6.223.5-91.3.03
Bismuth	400 mg, 99,998%, spare part for 6.223.5-91.1.30, 6.223.5-91.3.30	6.223.5-91.3.11
Cesium chloride	500 mg, 99.999%, spare part for 6.223.5-91.1.30	6.223.5-91.2.05
Aluminum	Wire Ø 1.0 mm, 99.999%, 400 mg, spare part for 6.223.5-91.1.30, 6.223.5-91.3.30	6.223.5-91.3.05
Silver	Wire Ø 0.5 mm, 99.99%, 400 mg, spare part for 6.223.5-91.3.30	6.223.5-91.3.06
Gold	Wire Ø 1.0 mm, 99.999%, 400 mg, spare part for 6.223.5-91.3.30	6.223.5-91.3.07
Nickel	Wire Ø 0.5 mm, 99.99%, 400 mg, spare part for 6.223.5-91.3.30	6.223.5-91.3.08
c-DTA® evaluation	Extension for <i>Proteus</i> ® software (DIL 402 <i>Expedis</i> )	SW-CDTA-70x.1B
c-DTA® evaluation	Extension for <i>Proteus</i> ® software (DIL 402 E)	SW-CDTA-69x.1B

<sup>1</sup> Temperature limited to the temperature range of the calibration materials.

DIL 402 *Expedis* Classic

DIL 402 *Expedis* Select

DIL 402 *Expedis* Supreme (HT)

DIL 402 E

TMA 402 F1/F3 *Hyperion*®

### Accessories for Length and Force Calibration of Dilatometers

Material	For Dilatometers	Order Number
Calibrating device with micrometer screw and holding set kit	DIL 402 E/7	6.214.1-20.0.00
Calibration device "displacement"	DIL 402 <i>Expedis</i>	DIL40200A30.010-00
Calibration device "force"	DIL 402 <i>Expedis</i>	DIL40200A30.020-00

### Accessories for Temperature Calibration of TMA 402 F1 and F3 Hyperion®

Material	Remarks	Order Number
Kit	For -70°C to 1000°C incl. 7 substances: adamantane, In, Sn, Zn, Pb, Al, Ag and certificate of compliance	6.217.1-92.1.00
Kit	For -100°C to 500°C incl. 6 substances; adamantane, In, Sn, Zn, Pb, Bi and certificate of compliance	TMA40200A00.921-30
Adamantane	400 mg, spare part for 6.217.1-92.1.00	6.217.1-92.1.09
Indium	Ø 4.5 mm × 0.25 mm, 10 pieces, spare part for 6.217.1-92.1.00	6.217.1-92.1.05
Tin	Ø 4.5 mm × 0.25 mm, 10 pieces, spare part for 6.217.1-92.1.00	6.217.1-92.1.06
Lead	Ø 4.5 mm × 0.5 mm, 10 pieces, spare part for 6.217.1-92.1.00	6.217.1-92.1.07
Zinc	Ø 4.5 mm × 0.25 mm, 10 pieces, spare part for 6.217.1-92.1.00	6.217.1-92.1.08
Aluminum	Wire Ø 1.0 mm, 99.999%, 400 mg, spare part for 6.217.1-92.1.00	6.223.5-91.3.05
Silver	Wire Ø 0.5 mm, 99.99%, 400 mg, spare part for 6.217.1-92.1.00	6.223.5-91.3.06
Gold	Wire Ø 1.0 mm, 99.999%, 400 mg, for calibration above 1000°C	6.223.5-91.3.07
Nickel	Wire Ø 0.5 mm, 99.99%, 400 mg, for calibration above 1000°C	6.223.5-91.3.08
Bismuth	400 mg, 99.999%, spare part for 6.223.5-91.1.30, 6.223.5-91.3.30	6.223.5-91.3.11
Spacer made of Al <sub>2</sub> O <sub>3</sub>	Ø 8 mm, thickness 0.63 mm; required for calibration with standard calibration materials	NGB800322

## Accessories for Length and Force Calibration of Dilatometers

Material	Remark	Order Number
Gauge block, 1 mm, class 0, with certificate	Calibration of the displacement transducer; for superior calibration results TMA40200A05.040-00 is recommended	NGB811924
Gauge block, 20 mm, with certificate	Calibration of automatic sample length detection	NGB811925
Special tool including metallic pushrod and precision weight, 100 g, OIML-class M2, with certificate	Force transducer calibration	TMA40200A05.030-00
Special tool including micrometer screw 0-6.5 mm, precision 0.002 mm, with certificate	Calibration of the displacement transducer	TMA40200A05.040-00



Pushrod and 100 g weight for force transducer calibration (order no. TMA40200A05.030-00)



Micrometer screw for displacement transducer calibration (order no. TMA40200A05.040-00)



Gauge blocks for calibration, 20 mm (order no. NGB811925) and 1 mm (order no. NGB811924)

The owner-managed NETZSCH Group is a leading global technology company specializing in mechanical, plant and instrument engineering.

Under the management of Erich NETZSCH B.V. & Co. Holding KG, the company consists of the three business units Analyzing & Testing, Grinding & Dispersing and Pumps & Systems, which are geared towards specific industries and products. With over 4,600 employees in more than 200 global production, sales and service companies, the NETZSCH Group has been offering its customers proximity and competent service for over 150 years.

When it comes to Thermal Analysis, Calorimetry (adiabatic & reaction), the determination of Thermophysical Properties, Rheology and Fire Testing, NETZSCH has it covered. Our 60 years of applications experience, broad state-of-the-art product line and comprehensive service offerings ensure that our solutions will not only meet your every requirement but also exceed your every expectation.

## Proven Excellence. ■

NETZSCH-Gerätebau GmbH  
Wittelsbacherstraße 42  
95100 Selb, Germany  
Tel.: +49 9287 881-0  
Fax: +49 9287 881-505  
at@netzsch.com  
www.analyzing-testing.netzsch.com



**NETZSCH**®

[www.netzsch.com](http://www.netzsch.com)