

NETZSCH

Proven Excellence.



Thermal Characterization of Photovoltaic Materials

Analyzing & Testing



Renewable Energy Our Solutions

Solar Energy

Renewable sources of energy – wind power, solar power, hydro-electric power, tidal power, geothermal energy and biomass – are essential alternatives to fossil fuels. Their use reduces our greenhouse gas emissions, diversifies our energy supply and reduces our dependence on unreliable and volatile fossil fuel markets.

The sun is the world's primary source of energy, and solar power systems can harness the sun's rays as a high-temperature, clean energy source for heat or electricity.

Photovoltaic (PV) electricity is emerging as a major power source due to its numerous environmental and economic benefits and proven reliability.

The use of a typical home PV system to replace fossil fuels could reduce CO₂ emissions by approximately 1.2 tons per year.

The Advantages of Solar Photovoltaic Electricity

- The "fuel" is free
- No moving parts
- Minimal maintenance
- Quick installation of modular systems – anywhere
- Produces no noise, harmful emissions or polluting gases
- Long lifetime and long-lasting high performance
- Modules can be recycled
- It brings electricity to remote areas
- It can be integrated into buildings
- Creates employment



Annual solar energy when compared to annual world energy consumption and finite non-renewable energy reserves.
Source: Eco Solar Equipment Ltd.

Thermal Analysis and Thermophysical Properties

The solar energy demand has grown at about 30% per annum over the past 15 years. To meet the growing demand, get products to market faster, and provide critical performance data to support competitive differentiation, research emphasis will be on the efficiency of PV systems, their lifetime and costs. This will spur new developments in material use and consumption, device design, and production technologies, and will drive the development of new concepts for increasing overall efficiency.

The product portfolio and applications knowledge of NETZSCH Analyzing & Testing in Thermal Analysis and Thermophysical Properties Testing rank among the

best in the market for meeting the high demands associated with the manufacturing of reliable, state-of-the-art technologies.

Our solutions consist of well-proven test methods for the research & development and quality control of materials used in the various branches of the photovoltaic industry.

Standardized test methods such as Laser Flash (LFA), Dilatometry (DIL) and Thermomechanical Analysis (TMA), Differential Scanning Calorimetry (DSC), Thermogravimetric Analysis (TGA), Simultaneous Thermal Analysis (STA), Dynamic-Mechanical Analysis (DMA/DMTA), and Dielectric Analysis (DEA) provide useful

information regarding the thermal, thermophysical and mechanical properties such as:

- Heat transfer
- Thermal conductivity/diffusivity
- Seebeck Coefficient and electrical conductivity
- Specific heat
- Curing behavior
- Processing properties
- Kinetic analyses of curing reactions of encapsulants
- Softening behavior of cured encapsulants
- Creep behavior
- Drying behavior of thick films and inks
- Thermal stability
- Contaminations

The Photovoltaic Effect

The photovoltaic effect is the basic physical process through which a PV cell converts sunlight into electricity. The energy of an absorbed photon is transferred to an electron in an atom of a semiconductor device. With its newfound energy, the electron is able to escape from its normal position in the individual atom in the semiconductor to become part of the current in an electrical circuit.

The PV cell has special electrical properties including a built-in electric field (p/n junction) which provides the voltage needed to drive the current through an external load.

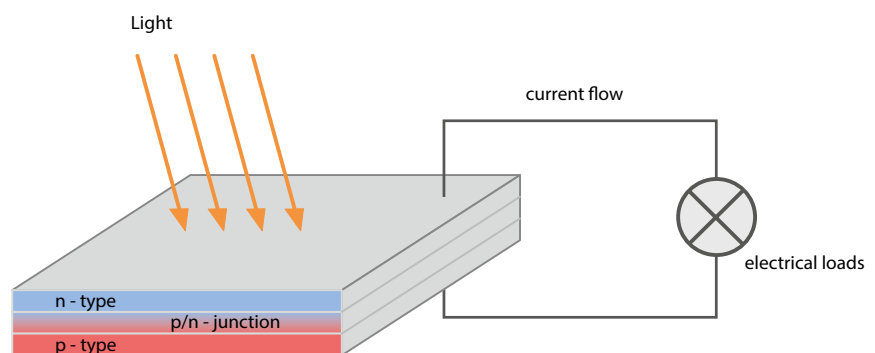

Photovoltaic effect (Alexandre-Edmond Becquerel, 1839).

When photons strike a PV cell, they may be reflected or absorbed, or pass right through. The absorbed photons generate electricity.



Differential Scanning Calorimetry

Differential Scanning Calorimetry (DSC) is one of the most frequently employed thermal analysis methods. It can be used to analyze nearly any energetic effect occurring in a solid or liquid during thermal treatment. DSC analysis provides valuable information for the research and quality control of solar cells, including:

- Analysis of amorphous encapsulants
- Information about process temperatures
- Specific heat for determination of the thermal diffusivity/ conductivity
- Kinetic analysis of the curing behavior

The DSC 300 *Caliris*[®] *Select/Supreme* variants are easy to handle and can be operated from -180°C to 750°C (H-Module)/650°C and -170°C to 600°C, respectively.

To cover a broader temperature range of -150°C to 1750°C, the DSC 500 *Pegasus*[®] model is available.

This instrument can be configured for up to six different furnace types, easily interchangeable by the user. The vacuum-tight design of the DSC 500 *Pegasus*[®] (up to 10⁻⁴ mbar) also ensures precise determination of the specific heat of high-performance materials in the temperature range from -150°C to 1600°C under highly pure atmospheres.



DSC 300 *Caliris*[®] with Automatic Sample Changer (ASC)

Simultaneous Thermal Analysis

Simultaneous Thermal Analysis (STA) generally refers to the simultaneous application of Thermogravimetric Analysis (TGA) and DSC to one and the same sample in a single instrument. The main advantage of this is that test conditions are perfectly identical for the TGA and DSC signals (same atmosphere, gas flow rate, vapor pressure of the sample, heating rate, thermal contact to the sample crucible and sensor, radiation effect, etc.). In addition, sample throughput is improved as more information is gathered from each test run.

The DSC and STA systems all meet the following instrument and application standards: ISO 11357, ISO 11358, ASTM E967, ASTM E968, ASTM E793, ASTM D3895, DIN 51004, DIN 51006, DIN 51007.

Measurement Information

DSC

- Specific heat
- Melting/crystallization behavior
- Solid-solid transitions
- Polymorphism
- Degree of crystallinity
- Glass transitions
- Cross-linking reactions
- Oxidative stability
- Purity determination
- Thermokinetic analysis

TGA

- Mass changes
- Temperature stability
- Oxidation/reduction behavior
- Decomposition
- Corrosion studies
- Compositional analysis
- Thermokinetic analysis



STA 509 Jupiter® coupled to
QMS 505 Aëolos



Stressing of the PV module

Thermal Expansion

Dilatometry

Many materials undergo changes to their thermomechanical properties during heating or cooling.

The thermal expansion is an important temperature effect which must be taken into account when modules are designed. The amount of spacing necessary to accommodate for such thermal expansion can be determined as a function of temperature (T) and the thermal expansion coefficients of the glass and the actual cell, as follows:

$$\delta = (\alpha_g C - \alpha_c D) \Delta T$$

α_g, α_c : expansion coefficients of the glass and the cell respectively
 C: cell center-to-center distance
 D: cell width



DIL 402 Expedit Supreme

Typically, interconnections between solar cells are looped to minimize cyclic stress. Double interconnects are used to protect against fatigue failure caused by such stress. In addition to interconnect stresses, all module interfaces are subject to temperature-related cyclic stress which may eventually lead to delamination.

Thermomechanical Analysis

Dilatometry (DIL) and Thermo-mechanical Analysis (TMA) provide valuable information regarding the mechanical properties under load and impact on solar cells. Investigations can be carried out on plastics and elastomers, paints and dyes, composite materials, adhesives, films and fibers, ceramics, glass and metals.

Standards

DIL determines the length change of samples under a negligible load (DIN 51045). The closely related TMA method also determines dimensional changes to solids, liquids or pasty materials as a function of temperature and/or time under a defined mechanical force (DIN 51005, ASTM E831, ASTM D696, ASTM D3386, ISO 11359 - Parts 1 to 3). In addition, it is possible to conduct measurements under modulated bending, tension or penetration force.

NETZSCH offers a broad range of dilatometers and TMA systems in the temperature range from -180°C up to 2800°C . All instruments fulfill the respective instrument and applications standards for dilatometry and thermomechanical analysis.



TMA 402 **F1** Hyperion®

Measurement Information

- Thermal expansion
- Coefficient of thermal expansion
- Expansivity
- Volumetric expansion
- Density change
- Sintering temperature
- Shrinkage steps
- Glass transition temperatures
- Softening points
- Phase transitions
- Creep behavior
- Influence of additives
- Rate-controlled sintering
- Thermokinetics

Dynamic Mechanical Analysis

Dynamic Mechanical Analysis (DMA or DMTA) allows for quantitative determination of the mechanical properties of a sample under an oscillating load as a function of temperature, time and frequency (DIN 53513, DIN EN ISO 6721, DIN 53440, DIN-IEC 1006, ASTM D4065, ASTM D4092, ASTM D4473, ASTM D5023, ASTM D5024, ASTM D5026, ASTM D5418).

The results portray the viscoelastic properties, typically provided as a graphical plot of E' , E'' , and $\tan \delta$ versus temperature. DMA identifies transition regions in plastics and resins such as the glass transition and may be used for quality control or product development in the temperature range from -170°C to 800°C .

In the area of photovoltaics, DMA is used to investigate the degree of curing, post-curing, and the kinetics of the cross-linking process for EVA or other encapsulants.

Measurement Information

The operable temperature range is well suited for obtaining application and processing information such as the glass transition temperature, onset of softening and brittleness.

- Design data concerning stiffness and damping properties (modulus values, damping factor)
- Data on the composition and structure of polymers and polymer blends (compatibility)
- Curing
- Aging

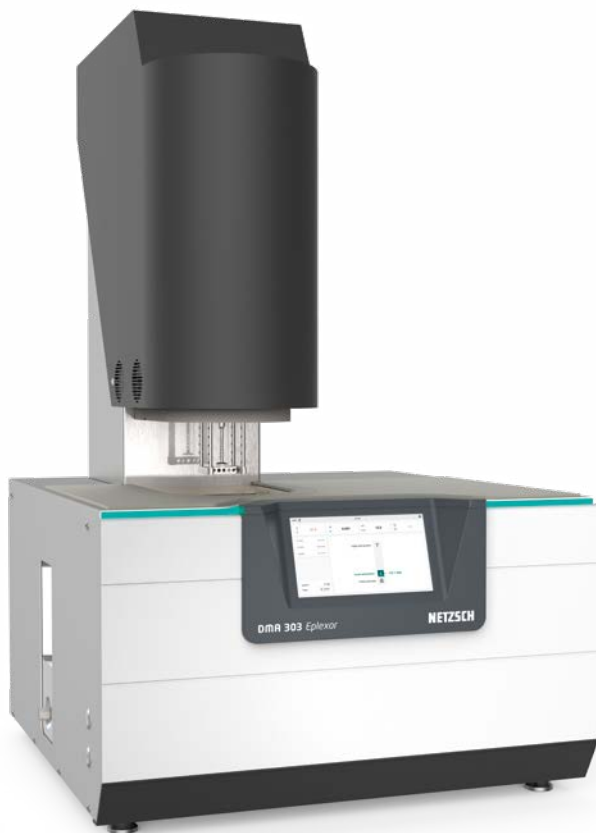

DMA 303 Eplexor®



Sample holder for measurements on pasty samples in compression with insert

Dielectric Analysis

For investigation of the curing behavior of thermo-setting resin systems, composite materials, adhesives and paints, Dielectric Analysis (DEA) in accordance with ASTM E2038 or E2039 has stood the test of time.

The great advantage of DEA is that it can be employed not only in the laboratory, but also in process. These systems can measure the ion conductivity – calculated from the dielectric loss factor – or its reciprocal value, the ion viscosity. Materials with slow curing times (> 3 min) or fast ones can be analyzed. Single- and multi-channel systems are available.

Measurement Information

- Cure rate
- Cure state
- Cure time
- Degree of cure
- Glass transition temperature and other polymer transitions
- Diffusion properties
- Aging and decomposition effects



Implantable sensors

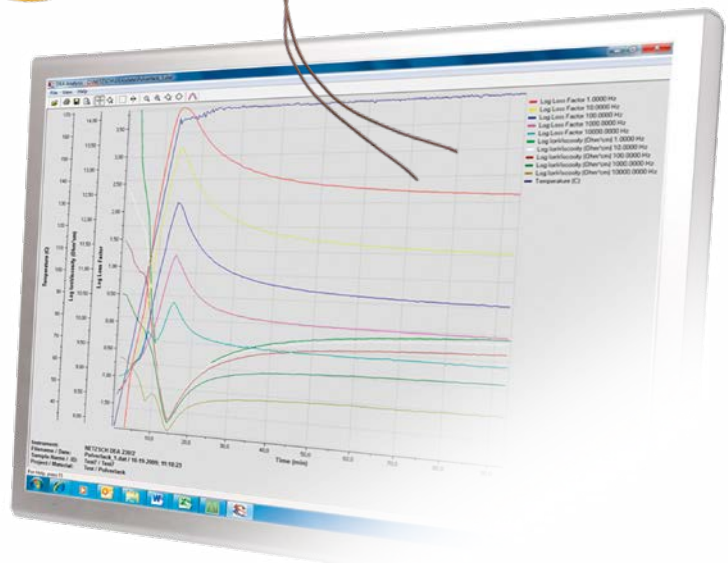



The Advanced Software Module *Thermokinetics*

Today, many different polymers are appearing on the market which might be considered for the PV lamination process. However, their thermal behavior is critical for such applications and must be investigated before decisions can be made.

For lamination, the time- and temperature-dependent curing reactions (e.g., of EVA copolymer films) play an especially important role. Fluctuations in the curing agent may occur and therefore require special attention.

The NETZSCH Advanced Software module *Thermokinetics* is capable of creating kinetic models of any chemical processes for which the reaction rate is a function of temperature and time. It can also be used to predict the behavior of chemical systems under user-defined temperature conditions and to achieve process optimization.

The software can analyze different types of thermal curves which show the changes in various measured material properties during the reaction process, including data from DSC, TGA, DIL, DMA, DEA, rheometry, FT-IR and mass spectrometry analyses, as well as temperature during adiabatic measurements.

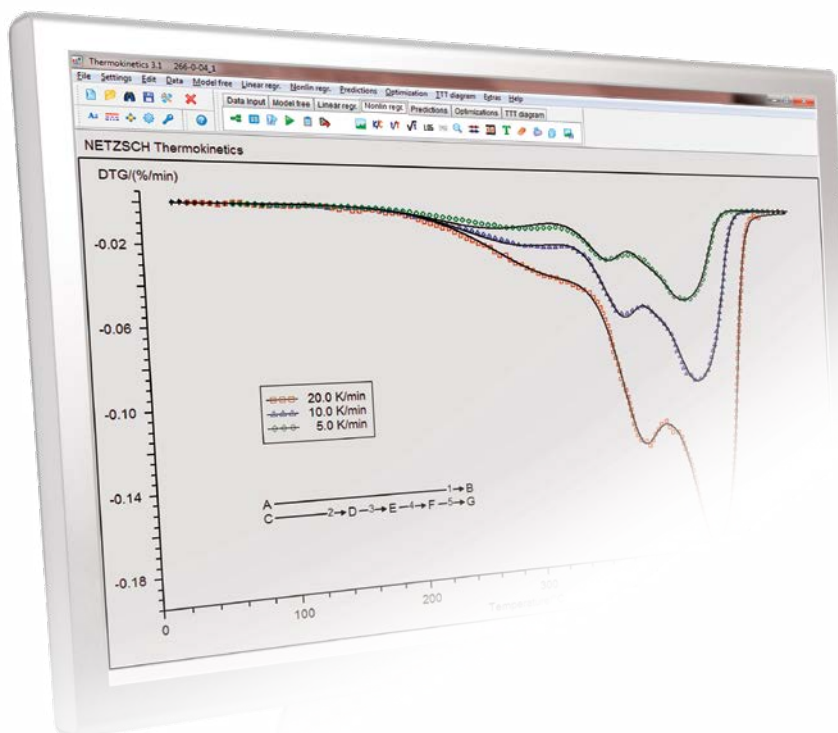

An analysis in *Thermokinetics* allows for the determination of the number of reaction steps, and for each step, the following values:

- Reaction type
- Activation energy
- Order of reaction
- Other kinetic parameters

The software allows for the analysis of heterogeneous reactions, including phase-boundary reactions, reactions with diffusion and nucleation, and reactions with partial diffusion control.

Various methods of kinetic analysis and predictions are integrated into the program:

- Model-free kinetic analysis (Friedman, Ozawa-Flynn-Wall, and ASTM E698)
- Model-fit using multivariate nonlinear regression (model definition, multiple-step reactions, 18 different reactions types, F-test regarding fit quality and significance of an additional step, graphic presentation)
- Multiple-step reactions (up to 6 steps)
- Isothermal prediction and prediction based on a user-defined temperature program

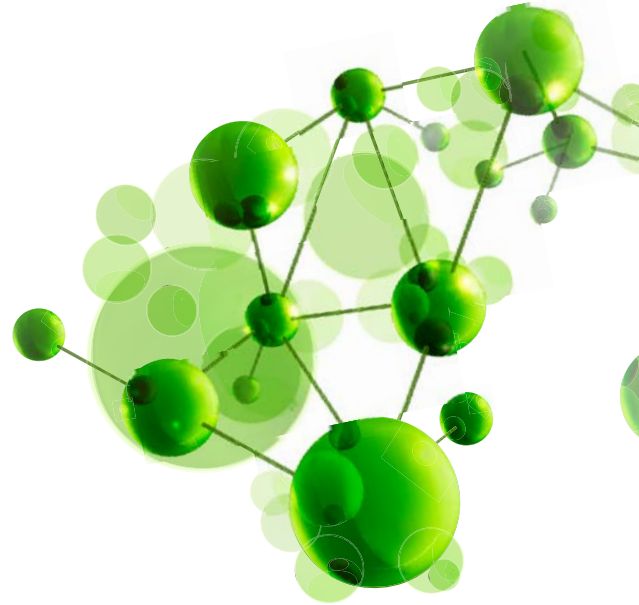

Thermal Management Task

Most of the solar radiation energy absorbed by solar cells is converted into thermal energy. This may cause the cells' junction temperature to rise unless the heat is efficiently dissipated to the environment. Heat removal is therefore an important issue in solar cell operation.

Encapsulation of solar cells affects the heat flow into and out of a PV module and thereby increases its temperature. This effect reduces the PV voltage and thus lowers the PV efficiency. In addition, this temperature increase can cause various malfunctions and degradation of the PV module. Elevated

temperatures increase stresses associated with thermal expansion.

The operating temperature of a module is determined by the equilibrium between the heat produced by the PV module, the heat lost to the environment and the ambient operating temperature.

These heat loss mechanisms depend on the emissive properties of the PV module, along with the ambient conditions (e.g., wind speed) and the thermal resistance of the module materials.

Laser Flash Technique

Investigation of the thermal conductivity and thermal diffusivity is important in overcoming thermal management problems during the PV module operation.

Measurement Information

The non-destructive and non-contact Laser/Light Flash technique is a fast and reliable absolute method for determining these thermophysical properties, including the specific heat. This data can then be used for:

- Prediction of the heat transfer and temperature profile as a starting point for the description of the processing behavior of multi-sheet systems
- Thermal diffusivity and thermal conductivity as input data for numerical simulation

LFA Method

The front surface of a plane-parallel sample is heated by a short light or laser pulse. The temperature rise on the rear surface is then measured versus time using an IR detector. The thermal diffusivity (a) and in most cases the specific heat (c_p) can be determined from the measured signal.

If the density (ρ) is known, the thermal conductivity (λ) can be determined as follows:

$$\lambda(T) = a(T) \cdot c_p(T) \cdot \rho(T)$$

where
 λ : thermal conductivity (W/m·K)
 ρ : bulk density (g/m³)
 c_p : specific heat (J/g·K).

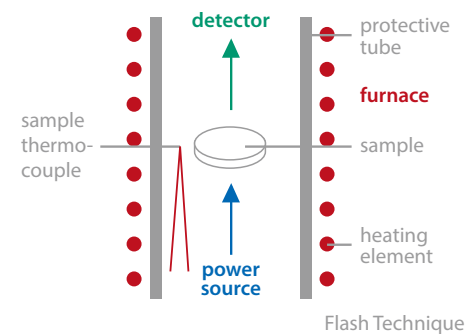

LFA measurement principle introduced by Parker et al. 1961

LFA Software

- Accurate pulse length correction, pulse mapping
- Heat-loss corrections
- Non-linear regression for Cowan fit
- Improved Cape-Lehmann model through consideration of multi-dimensional heat loss and non-linear regression
- Determination of contact resistance in multi-layer systems
- Radiation correction for semi-transparent samples
- 2- or 3-layer systems: analysis by means of non-linear regression and consideration of heat loss
- Model wizard for selecting the optimum evaluation model
- Determination of specific heat by means of a comparative method and standard samples
- Integrated database

LFA 717 *HyperFlash*®

The LFA 717 *HyperFlash*® is a Xenon flash-based system. It covers the wide temperature range from -100°C to 500°C. It stands for very high efficiency (with its sample changer for 16 samples), extremely fast data acquisition and offers a patented lens system (*ZoomOptics*; patent no.: DE 10 2012 106 955 B4 2014.04.03) between the sample and the detector.

The broad temperature range is handled by a single instrument setup, so it is not necessary to change either the detector or the furnace. The ultra-fast recording of measurement data also makes this system capable of measuring thin samples (e.g., polymer films of 30 µm) by selecting an optimum sampling rate and pulse width. The patented pulse mapping system accounts for the finite pulse width effect and heat losses (patent no.: US7038209; DE1024241).

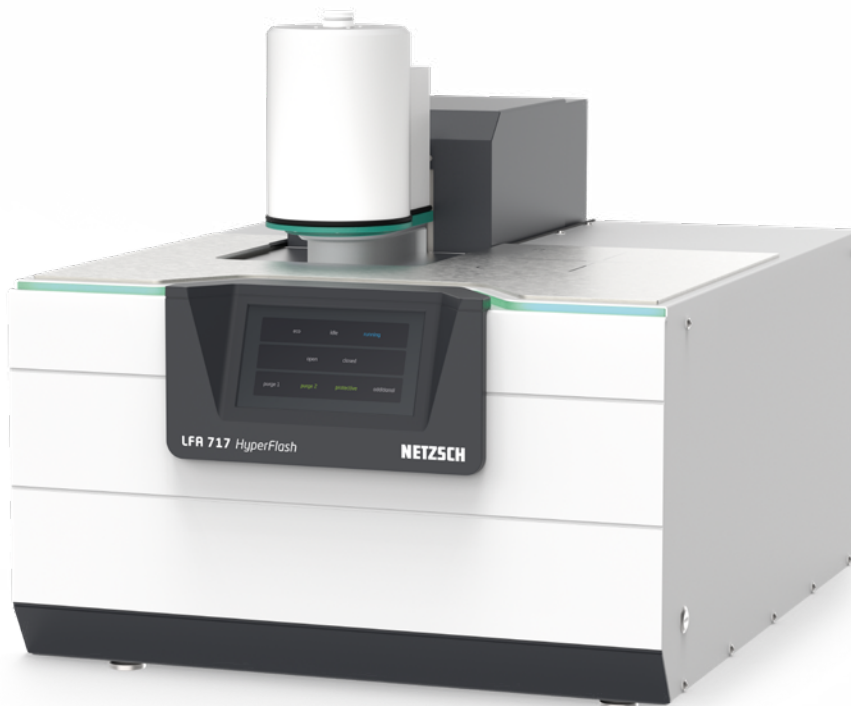

LFA 717 *HyperFlash*®

Applications – Silicon

Thermophysical Properties of a Silicon Sample

Silicon-based technologies have always played a significant role within the energy industry. They currently dominate the solar energy market with a market share of over 90 percent.

In addition, the continual improvements being made to silicon (e.g., through silicon crystal growth techniques and enhancements to purity, efficiency, etc.), are securing its strong position within the energy industry over the foreseeable future.



Ingots of silicon. Ingots are sliced into individual wafers to make a variety of semiconductor devices, including solar cells.

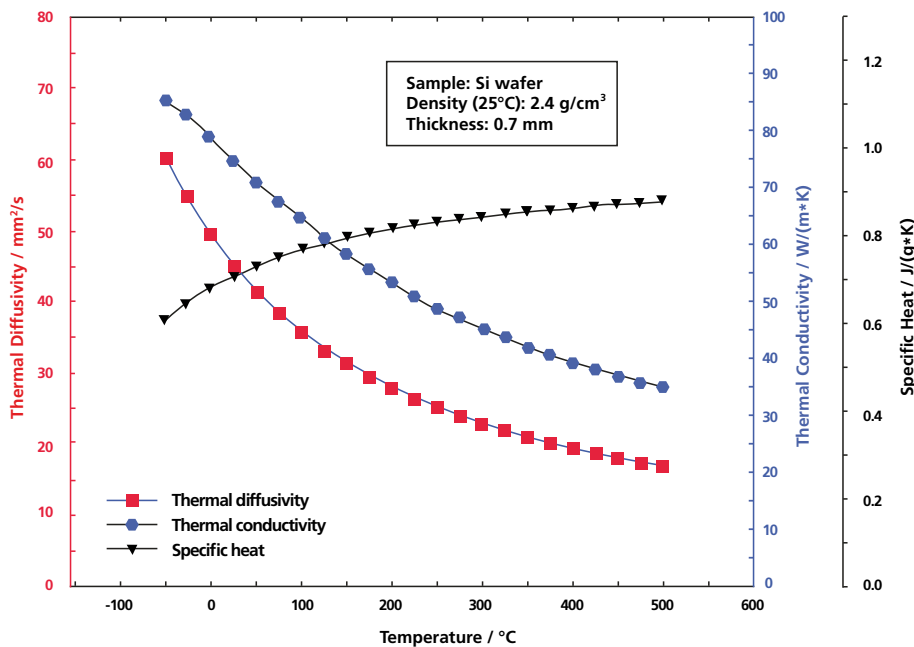

LFA and DSC measurement of a silicon wafer between -100°C and 500°C.

Determination of the thermal diffusivity and thermal conductivity of semi-conductor materials is necessary for scientific, technical and engineering work. The drive in the solar industry is to improve the efficiency of the PV modules produced. Since higher efficiency is a direct function of increased thermal conductivity, it is important to be able to determine these values.

In this example, the thermo-physical properties of a silicon wafer were measured with the LFA 457 *MicroFlash*®. In the temperature range from -100°C to 500°C, the thermal conductivity and thermal diffusivity continuously decrease. Determination of the specific heat was carried out with DSC. The standard deviation of the data points is < 1%.

Organic Contaminations on Silicon Wafers

The purity of silicon wafers used in modern technologies is one of the most important quality control parameters. Organic contamination can be investigated by using Thermal Analysis methods such as TGA, DSC or TGA-DSC (STA) coupled to an evolved gas analyzer.

Several hyphenated techniques are available in the temperature range from -180°C to 2400°C . They include:

- TGA, DSC, or STA-MS via capillary coupling
- TGA, DSC, or STA-MS via *SKIMMER* coupling
- TGA, DSC, or STA-FT-IR
- TGA or STA-GC-MS

These hyphenated techniques may also include the simultaneous coupling of MS and FT-IR to a thermal analyzer.



Quality control of silicon wafers is essential for high-quality products

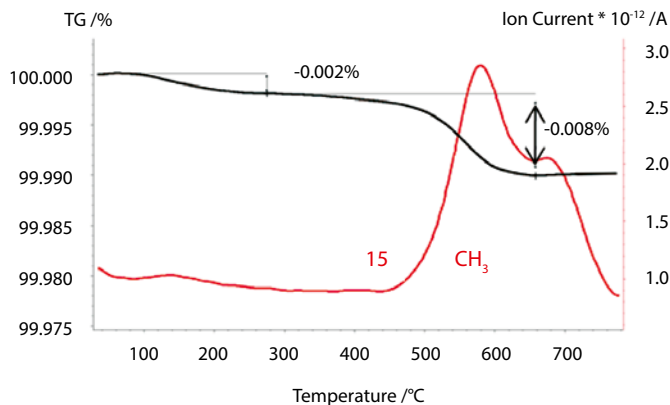

In this example, a silicon wafer was measured with the simultaneous thermal analyzer *STA Jupiter*[®] coupled to the mass spectrometer *QMS Aëolos*.

The large sample (1.6 g) was placed into an Al₂O₃ crucible (volume 5 ml) and heated to 800°C at 10 K/min under synthetic air. Two very small mass-loss steps (0.002% and 0.008%) occur prior to 700°C due to the release of organic components.

To ensure clear demonstration, only the mass numbers *m/z* 15, 51, and 78 are presented here.

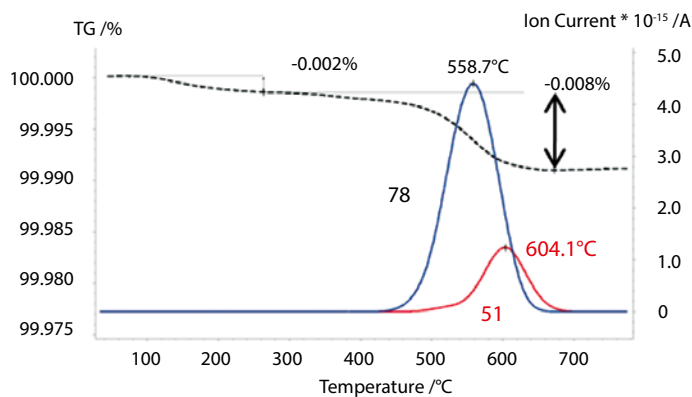

STA-MS measurement of a silicon wafer; mass numbers *m/z* 15, 78 and 51 are correlated to the mass-loss step between 500°C and 800°C.

Applications

Thermal Management – Heat Transfer Materials (TIMs)

Heat must be dissipated from electronic devices quickly and efficiently to ensure optimal performance and to prevent premature component failure. Like CPUs and GPUs, LED inverters as well as photovoltaic inverters require excellent thermal management. Thermal interface materials (TIMs) are available as greases, tapes, filled elastomer pads and phase-change materials.

Many of these materials require a mechanical clamping pressure to hold the parts together and to maintain the performance of the thermal joint. The applied pressure can help expel air and produce more complete wetting of the material at the interface.

The Laser Flash method (LFA) is commonly applied to measure the thermal conductivity (W/mk) of TIMs. It monitors the thermal diffusivity (mm^2/s), which is a measure of how quickly a temperature disturbance can propagate through a material.

A special clamping fixture was implemented to allow measurement of the thermal resistance and thermal conductivity of interface materials in a sandwich configuration under a known clamping pressure.

The total thermal resistance as a function of gap thickness at each nominal pressure level is plotted and linear regression is performed. The y-axis intercept or zero gap thickness resistance represents the contact resistance, and the material bulk thermal conductivity is determined using the reciprocal of the slope. The results show that once a low clamping pressure is applied, the contact resistance is reduced and not very sensitive to pressure.

A possible explanation for the increase in thermal conductivity with clamping pressure would be that there is a small increase in the material density and conductive filler particle-to-particle contact due to constraints in the material flow caused by surface adhesion to the substrates.

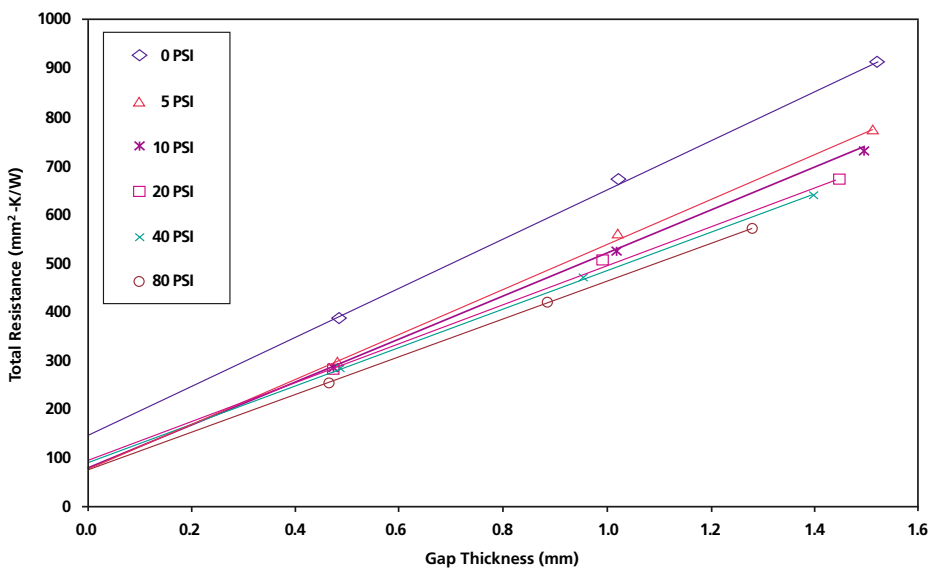

Total resistance versus gap thickness under different pressures calculated by LFA measurements of a 3M 5590H pad (thickness 0.5 mm, 1 mm and 1.5 mm).

Nominal Clamping Pressure (PSI)	Thermal Conductivity (W/(m·K))	2(Rcon) ((mm²·K)/W)
0	1.98	144.0
5	2.15	74.4
10	2.28	78.4
20	2.49	94.4
40	2.53	89.0
80	2.5	73.5

LFA measurement results of a TIM: Thermal conductivity and thermal resistance as a function of clamping pressure

Thin-Film Photovoltaics

Thin-film solar cells based on direct semiconductors with high absorption coefficients rank among the most promising cell types. This technology is expected to lower manufacturing costs while maintaining high product efficiencies.

In fact, the highest laboratory efficiencies are reported for thin-film solar cells based on the chalcopyrite semiconductor system Cu (In,Ga) (S,Se). The TG-DSC (DTA)-MS can provide important information for studies of physical-chemical properties such as:

- Melting point, evaporation
- Characterization of gas species during heating
- Determination of impurities
- Temperature of incongruent melting

These ternary semiconductors have a direct band gap, in contrast with silicon, which has an indirect band. Proper selection of the elements allows this band gap to be optimized to the required application.

These materials do also have some disadvantages. These lie in their physical-chemical properties and their stoichiometry, which makes crystal growth and/or the manufacturing of epitaxial layers relatively complicated.



Flexible solar cells

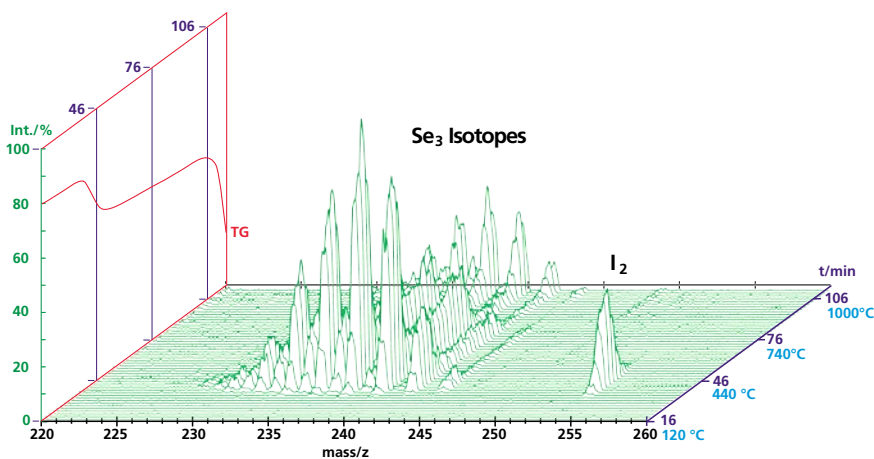

STA-MS SKIMMER measurement of the chalcopyrite CuGaSe_2

CuGaSe_2 with its band gap of 1.68 eV is a promising material for thin-film photo-voltaics, since it can act as the top cell in a PV tandem device with CuInSe_2 as the bottom cell. CuGaSe_2 was synthesized from Cu, Ga, and Se taken in stoichiometric amounts.

At 450°C, the evaporation of Se_3 is detected by means of the isotope distribution between m/z 230 and m/z 245, which indicates a non-stoichiometric material.

The presence of iodine shows that it was used as a mineralizer for synthesis. The presence of Se at temperatures higher than 900°C is due to the thermal degradation of CuGaSe_2 . Regulation of the Se vapor pressure is required to control the stoichiometry.

Applications

Encapsulation Materials

One of the most important and critical steps in PV production is the encapsulation of solar cells. This encapsulation should allow for efficient power generation in any application while protecting the cells from damage or corrosion caused by mechanical shock or the environment (moisture, rain, snow or dust). Thermal treatment of the polymer resin during the encapsulation process is performed in the laminator in two steps, the lamination and the curing. This treatment effectuates a bonding of the multiple layers of materials with thermo-sensitive polymer films.

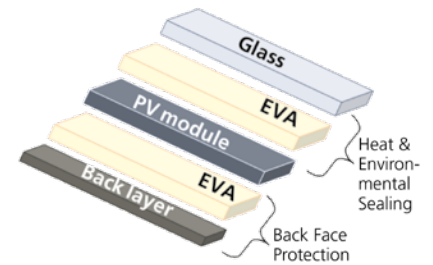

Packaging of the PV module protects against damage to solar cell circuit and electrical insulation by the environment

EVA

The most widely used encapsulant is EVA (ethylene vinyl acetate copolymer), due not only to its high electrical resistivity, low fusion and polymerization temperature, and low water absorption ratio, but also to appropriate optical transmission properties. As the polymerization reaction is irreversible, the thermal treatment of the PV cell encapsulation is crucial. The quality and lifetime of the PV modules/arrays depend on the caliber of this production process.

In this example, Dielectric Analysis of an EVA sample was carried out in the lab furnace of the DEA 230/1 *Epsilon*. The DEA 230 system is optimally designed for materials with standard to long curing times (> 3 min).

Time and temperature ramps can be easily programmed at heating rates of up to 40 K/min. In addition, all disposable comb sensors can be used in the furnace to ensure a broad application range of the system setup. The multi-frequency measurement (with frequencies between 1 Hz and 10000 Hz) was carried out, and the ion viscosity ($\Omega \cdot \text{cm}$) was monitored. Presented here is the behavior of the ion viscosity at 1 Hz.

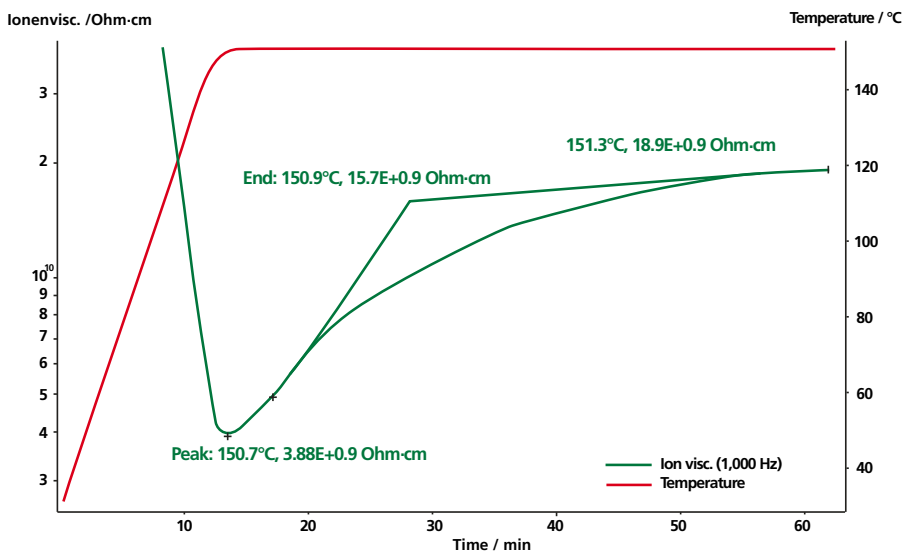

Test result of the curing of EVA at 150°C with the DEA at 1 Hz

The cross-linking reaction by using peroxide was observed under isothermal conditions at 150°C.

The increase in the ion viscosity correlates with the increase in the degree of cure. After 60 min, the ion viscosity remains nearly constant, which indicates that the cross-linking reaction has essentially finished.

Quality Control of EVA with DSC

Differential Scanning Calorimetry (DSC) is well suited for performing quality control analyses on commercially available EVA films with respect to their glass transition temperature, melting behavior and

degree of curing. Competitive materials can easily be compared, and the cross-linking process can be investigated as a function of temperature (dynamic tests) or time (isothermal tests).

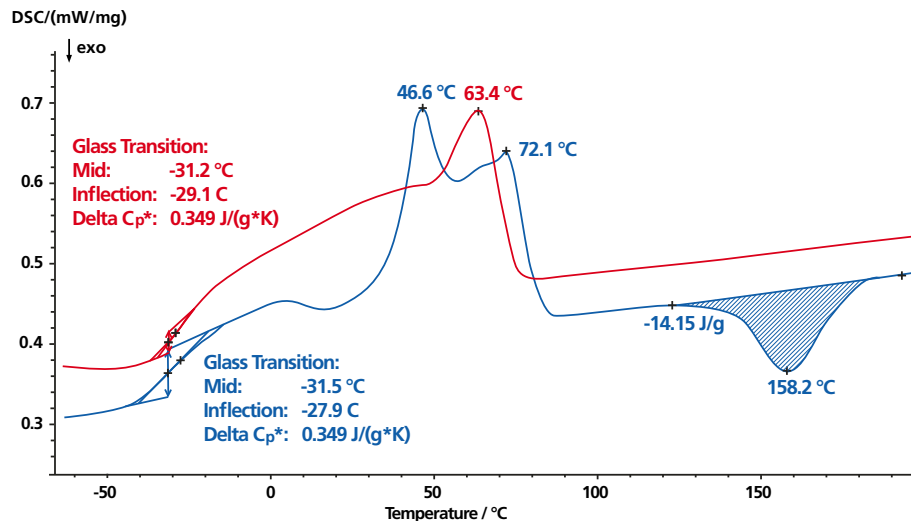

1st and 2nd heating of a commercially available EVA film (Mitsui Chemicals Fabro)

In this example, DSC measurements* were carried out on an EVA film sample of approx. 7 mg at heating rates of 10 K/min.

These DSC experiments were performed at the Federal Institute for Materials Research and Testing ("BAM"), Germany.

In the 1st heating (blue curve), the glass transition temperature at -28°C (inflection point) is followed by an endothermic double peak between 50°C and 100°C. This melting behavior can be correlated to a lamellar thickness distribution. The exothermic peak at 158°C indicates the exothermic cross-linking reaction. Noticeable is the rather low reaction

enthalpy (-14.15 J/g) in comparison to epoxy resins (typically between -400 J/g and -500 J/g).

In the 2nd heating (red curve), the glass transition occurred at almost the same temperature. The endothermic double peak between 40°C and 80°C has changed to a broad shoulder with its maximum at 63°C. The higher the crystal thickness, the higher the melting temperature. Therefore, the change from a peak into a broad shoulder is an indication of a distribution of crystals with reduced thickness as a consequence of the thermal treatment in the 1st run.

No exothermic reaction peak is present in the 2nd run, indicating that the cross-linking process was finished after the 1st heating.

*Our thanks to Dr. W. Stark and M. Jaunich from the Federal Institute for Materials Research and Testing ("BAM") in Berlin for the measurements and discussion. The results are published in Polymer Testing 30 (2011) 236-242.

Applications

Investigation of the Cross-Linking Process by DMA

Both DSC and DMA tests can be used to investigate the degree of curing, post-curing, and the kinetics of the cross-linking process of EVA. While DSC measurements are also influenced by the degradation of peroxide (curing agent for EVA), DMA measurements are sensitive only to the curing

process, thereby allowing for a detailed study of the glass transition temperature.

However, a comparison of the DMA and DSC analyses shows that the results provided by the two methods are consistent with each other. Therefore, the lamination process can be optimized by using a kinetic evaluation of either the DSC or DMA data. The advantage in using DMA is that the results already reflect the temperature- and frequency-dependent viscoelastic properties.

Determination of the Glass Transition Temperature of Uncured EVA

These DMA tests were carried out at the Federal Institute for Materials Research and Testing ("BAM"), Germany*. The multi-frequency measurement (0.33 Hz, 1 Hz, 3.33 Hz, 10 Hz and 33.3 Hz) was performed in the dual cantilever sample holder at a heating rate of 2 K/min and an amplitude of 40 μm .

The observed behavior of the glass transition is typical. The storage modulus E' strongly decreases at -40°C while E'' shows a clear peak. The glass transition is a function of frequency: the higher the frequency, the higher the glass transition temperature.

These values are used to determine the activation energy of the glass transition temperature. A linear correlation is found between $\ln(f)$ and $1/T$. From the slope of the straight line, an apparent activation energy can be calculated. This activation energy amounts to 328 kJ/mol, a value in the range typical for a glass transition.

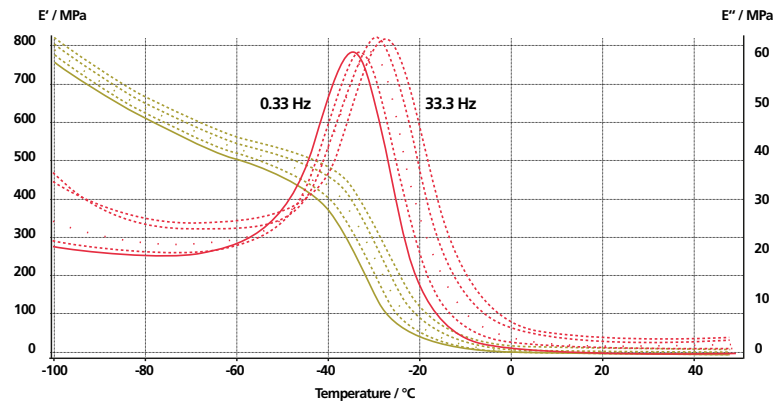

Storage modulus E' and loss modulus E'' of an uncured EVA at frequencies between 0.33 Hz and 33.3 Hz. The peak temperature of E'' shifts from -34.7°C to -27.6°C with an increasing frequency.

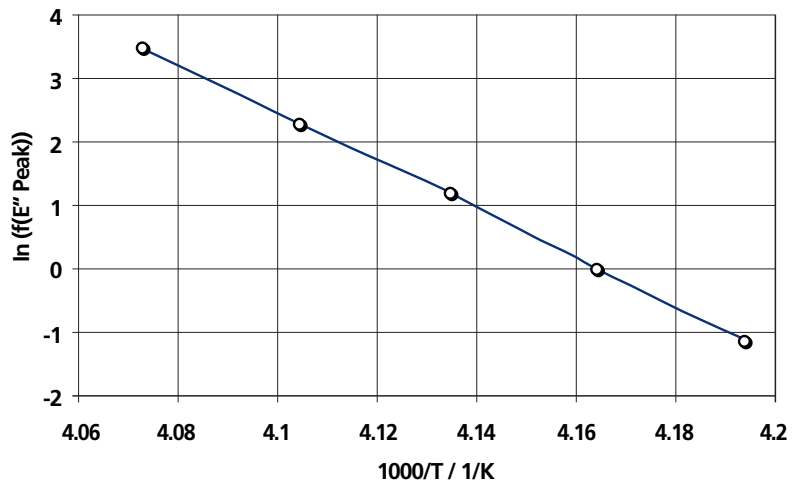

Arrhenius plot of logarithm of the measuring frequency versus the reciprocal E'' peak temperature

*Our thanks to Dr. W. Stark and M. Jaunich from the Federal Institute for Materials Research and Testing ("BAM") in Berlin for the measurements and discussion. The results are published in Polymer Testing 30 (2011) 236-242.

Adhesives

Flexible modules and solar cells have an impressive range of applications. Instead of lying flat and rigid on roofs, flexible solar cells and modules can also be adapted to curved and non-standard building shapes.

For such applications, the encapsulation must also be flexible and transparent. In addition, it must protect sensitive materials, especially against degradation due to humidity and oxygen. Such protection is achieved by bonding the cover film with low-permeation adhesives.

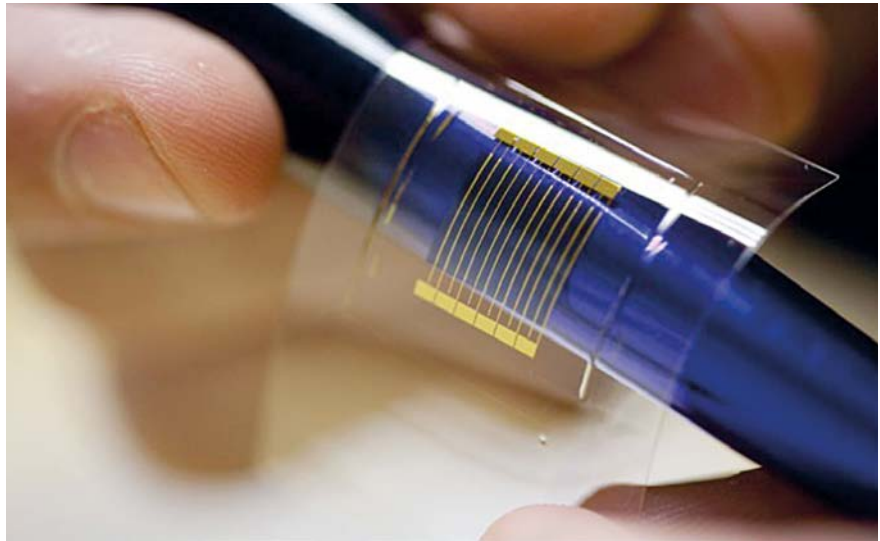

Ultrathin, semi-transparent solar cells can be printed on any material; University of Illinois, published in New York Times, April 29, 2009

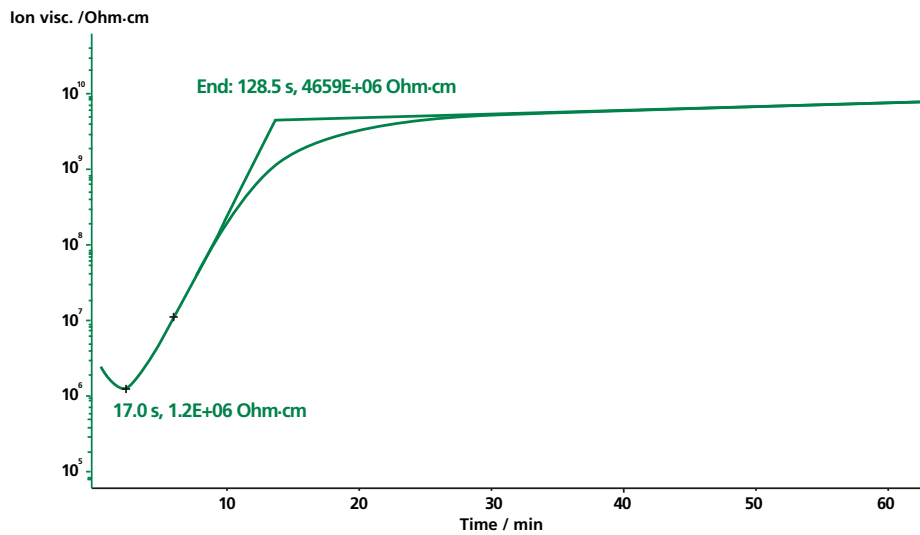

UV curing of a cationic epoxy resin at room temperature with the DEA 231/1 at 1000 Hz

Besides exhibiting excellent adhesion, special UV-curing sealants with a high water barrier effect have been developed which guarantee a long life time.

The epoxy adhesive investigated here (DELO Katiobond LP655) stands out for its low water vapor permeation and short curing time.

The fast curing can be observed with the DEA 231/1 by using an IDEX sensor and applying a frequency of 1000 Hz. The sample layer, which was approx. 200 mm thick, was exposed to UV light (intensity 55 mW/cm² to 60 mW/cm²) for 60 s at room temperature.

After 17 s of light exposure, curing begins. This is evidenced by the increase in the ion viscosity. The adhesive is completely cured after approx. 350 s.



Expertise in Service

Our Expertise – Service

All over the world, the name NETZSCH stands for comprehensive support and expert, reliable service, before and after sale. Our qualified personnel from the technical service and application departments are always available for consultation.

In special training programs tailored for you and your employees, you will learn to tap the full potential of your instrument.

To maintain and protect your investment, you will be accompanied by our experienced service team over the entire life span of your instrument.

Summary of Our Services

- Installation and commissioning
- Hotline service
- Preventive maintenance
- Calibration service
- IQ / OQ / PQ
- On-site repairs with emergency service for NETZSCH components
- Moving / exchange service
- Technical information service
- Spare parts assistance



Proven Excellence in Lab & Services

NETZSCH Analyzing & Testing offers a broad spectrum of services for your thermal analysis instruments – from the basics to complete value retention of your instrument, including various training programs and application support.

The owner-managed NETZSCH Group is a leading global technology company specializing in mechanical, plant and instrument engineering.

Under the management of Erich NETZSCH B.V. & Co. Holding KG, the company consists of the three business units Analyzing & Testing, Grinding & Dispersing and Pumps & Systems, which are geared towards specific industries and products. A worldwide sales and service network has guaranteed customer proximity and competent service since 1873.

When it comes to Thermal Analysis, Calorimetry (adiabatic & reaction), the determination of Thermophysical Properties, Rheology and Fire Testing, NETZSCH has it covered. Our 60 years of applications experience, broad state-of-the-art product line and comprehensive service offerings ensure that our solutions will not only meet your every requirement but also exceed your every expectation.

Proven Excellence. ■

NETZSCH-Gerätebau GmbH
Wittelsbacherstraße 42
95100 Selb, Germany
Tel.: +49 9287 881-0
Fax: +49 9287 881-505
at@netsch.com
<https://analyzing-testing.netsch.com>



NETZSCH®

www.netsch.com